

Increasing Panel Design Flexibility Using the 320-nm Laser on the ID7000™ Spectral Cell Analyzer

The Sony ID7000™ spectral cell analyzer may be equipped with a 320-nm laser to expand the way biological samples are analyzed, ensuring accurate visualization of fluorescent populations. In this article, we provide an overview of the method and benefits of spectral analysis with emission signals from 320-nm laser excitation, using currently available fluorochromes, compared to the same panel without the 320-nm laser.



Introduction to the ID7000 spectral cell analyzer optics

The ID7000 spectral cell analyzer is built using an innovative design that may include up to seven excitation lasers (320, 355, 405, 488, 561, 637, and 808 nm), optical fibers, diffraction grating, 32-channel array photomultiplier tubes (PMTs), single-channel PMTs, and a standard AutoSampler (**Figure 1A**). A photograph of the excitation laser module is shown in **Figure 1B**. The optics schematic diagram is shown in **Figure 1C**. The excitation lasers are aligned as spots, which are spatially separated for all seven lasers. Fluorescence emission is captured by optical fibers and delivered to each detection deck. A diffraction grating was introduced to disperse the emission fluorescence signal. A custom micro lens array assembly then focuses each band of light onto a specific channel of the PMT array, which prevents loss of fluorescent photons to a boundary mask. **Figure 1D** shows a detection optics map, which highlights the relationship between wavelengths and PMT channels. The 32-channel PMTs and single-channel PMTs detect light from 360 to 920 nm. The detection range for 320-nm excitation is from 360 to 840 nm with a total of 35 PMT channels available.

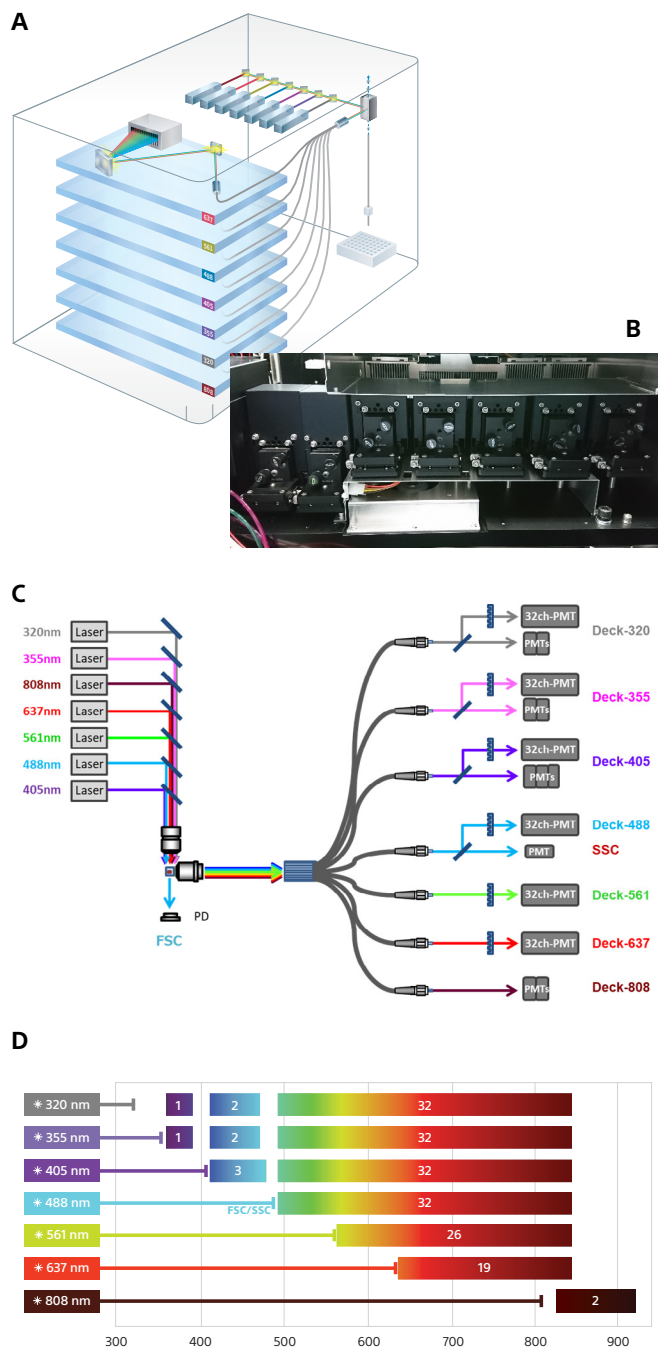

Figure 1. Technical overview of the ID7000 system optics

Stability of the 320-nm laser

The study was conducted using AlignCheck particles (Sony Biotechnology Inc. catalog no. AE700510). These particles were run on an ID7000 spectral cell analyzer with six lasers ON (320, 355, 405, 488, 561, and 637 nm) for 84 days. **Figure 2A** shows the emission spectra when excited by the 320-nm laser (20 mW at laser output) visualized in the ID7000 Software. AlignCheck particles have high fluorescence intensity over a wide range of wavelengths, from 360 to 840 nm. **Figure 2B** depicts Mean intensities of Area and Height of AlignCheck particles at a certain detection region, roughly 624 to 635 nm (red highlighted in (A)), calculated and tracked for 84 days. This region was selected to represent all 320-nm laser detection channels. These mean intensity values of both Area and Height show stable performance with the 320-nm laser. In addition, the rCV of these values was about 3.0%, which also shows good performance of the 320-nm laser for a long time.

Figure 2C shows the histogram plots generated using InSpeck™ Blue microspheres (Thermo Fisher Scientific catalog no. I7221). Intensities of Area of seven populations at roughly 419 to 472 nm with the 320-nm laser (right) and 355-nm laser (left) are shown.

Figure 2D depicts InSpeck Blue microspheres analyzed using the linear scale with the 320-nm laser excitation. The peaks were visualized using histograms and a virtual filter (roughly 419 to 472 nm). All peaks were set to 10^5 to normalize each population to the same region of the detector. The distribution of each peak was symmetrical, indicating low noise and a consistent beam shape for the 320-nm laser.

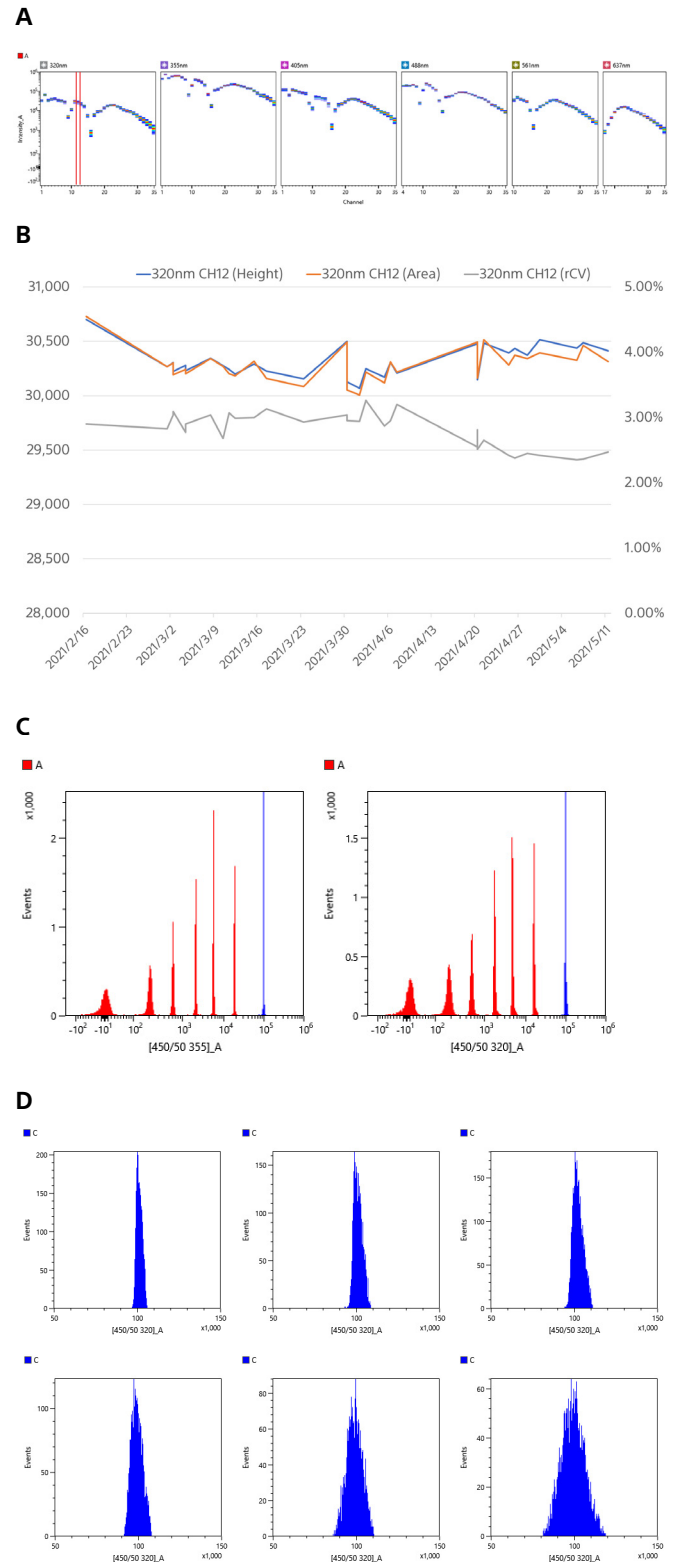

Figure 2. Demonstration of the stability of the 320-nm laser

Improvement of the spillover spreading values with 320-nm laser

Spillover spread (SS) values were compared with and without the 320-nm laser to identify the benefit from emission spectra from the 320-nm laser excitation of currently available fluorochromes. The table shows the combination of fluorochromes for this testing. Forty-one colors and fifty colors were selected to compare the difference in the spillover spreading values between 320 ON and 320 OFF.

In both cases, when the 320-nm laser was ON, the total value of spillover spreading was improved. For 41 colors, the total SS value without the 320-nm laser was 2,695.0 and with the 320-nm laser was 2,161.3. For 50 colors, the total SS value without the 320-nm laser was 9,661.6 and with the 320-nm laser was 7,806.5. This results in an improved signal-to-noise ratio after spectral unmixing, which allows users to have more flexibility in their panel designs.

Fluorochrome	Marker	41 color	50 color
Alexa Fluor® 532	CD19	N/A	✓
Alexa Fluor® 514	CD39	✓	✓
Alexa Fluor® 488	CD8a	✓	✓
Alexa Fluor® 647	CD4	✓	✓
Alexa Fluor® 700	CD123	✓	✓
APC	CD27	✓	✓
APC-Cy™7	CD16	✓	✓
APC-eFluor® 780	CD38	N/A	✓
BUV395	CD45RA	✓	✓
BUV496	CD4	✓	✓
BUV563	CD14	✓	✓
BUV661	CD4	✓	✓
BUV737	CD56	✓	✓
BUV805	CD4	✓	✓
BV421	CD19	✓	✓
BV480	IgD	✓	✓
BV510	CD3	✓	✓
BV570	HLA-DR	✓	✓
BV605	CD45RA	✓	✓
BV650	CD183 (CXCR3)	✓	✓
BV711	CD196 (CCR6)	✓	✓
BV750	CD4	✓	✓
BV785	CD197 (CCR7)	✓	✓
CF® 568	CD4 (EDU-2)	N/A	✓
eFluor® 450	CD161	N/A	✓
eVolve™ 605	CD4	N/A	✓
eVolve™ 655	CD27	N/A	✓

Fluorochrome	Marker	41 color	50 color
Pacific Blue™	CD3	✓	✓
Pacific Orange™	CD4	✓	✓
PE	CD45RO	✓	✓
PE/Dazzle™ 594	CD24	✓	✓
PE-Alexa Fluor® 610	CD24	✓	✓
PE-Alexa Fluor® 700	CD4	✓	✓
PE-Cy™5	CD95(Fas)	✓	✓
PE-Cy™5.5	CD8a	✓	✓
PE-Cy7	CD7	✓	✓
PerCP	CD45	✓	✓
PerCP-Cy5.5	CD127	✓	✓
PerCP-eFluor® 710	TCR g/d	✓	✓
Qdot™ 525	CD39	✓	✓
Qdot™ 565	CD39	✓	✓
Qdot™ 585	CD39	✓	✓
Qdot™ 605	CD4	✓	✓
Qdot™ 625	CD39	✓	✓
Qdot™ 655	CD4	✓	✓
Qdot™ 705	CD4	✓	✓
Qdot™ 800	CD4	N/A	✓
Super Bright 645	CD8	N/A	✓
Super Bright 702	CD4	✓	✓
Super Bright 780	CD4	N/A	✓

A

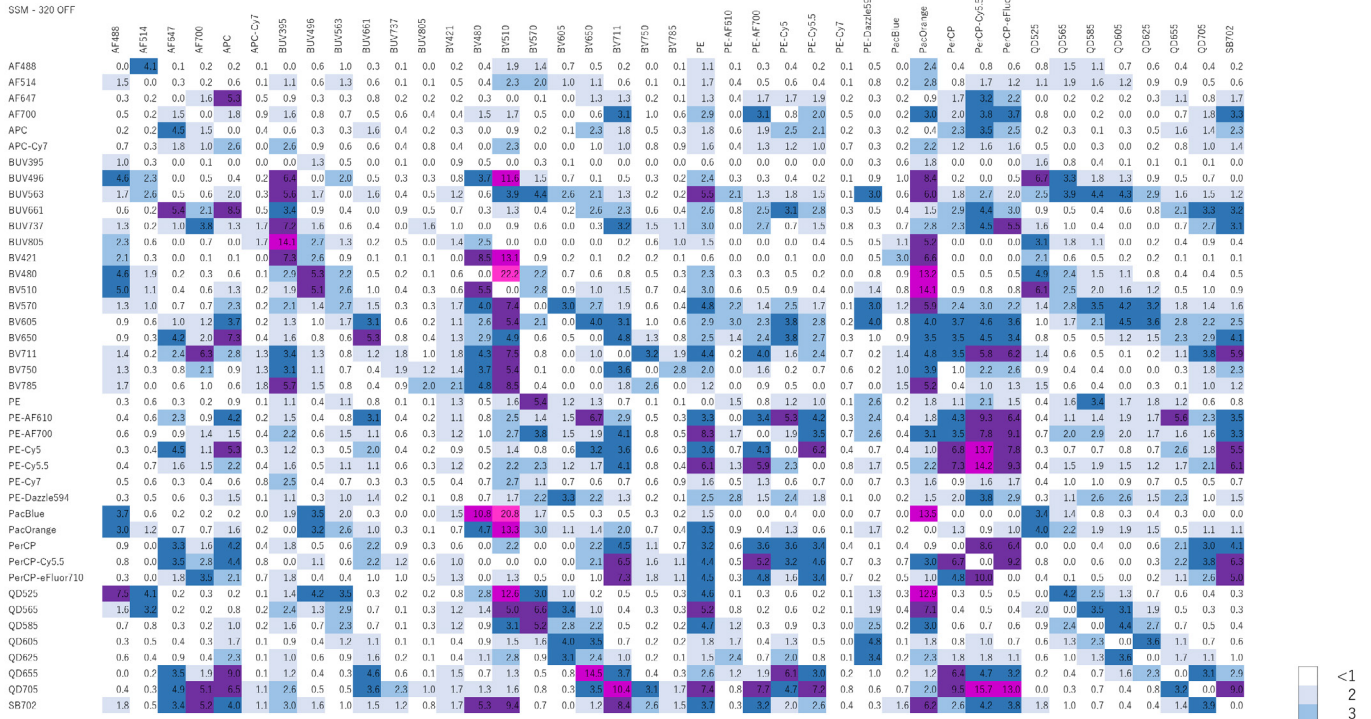

B

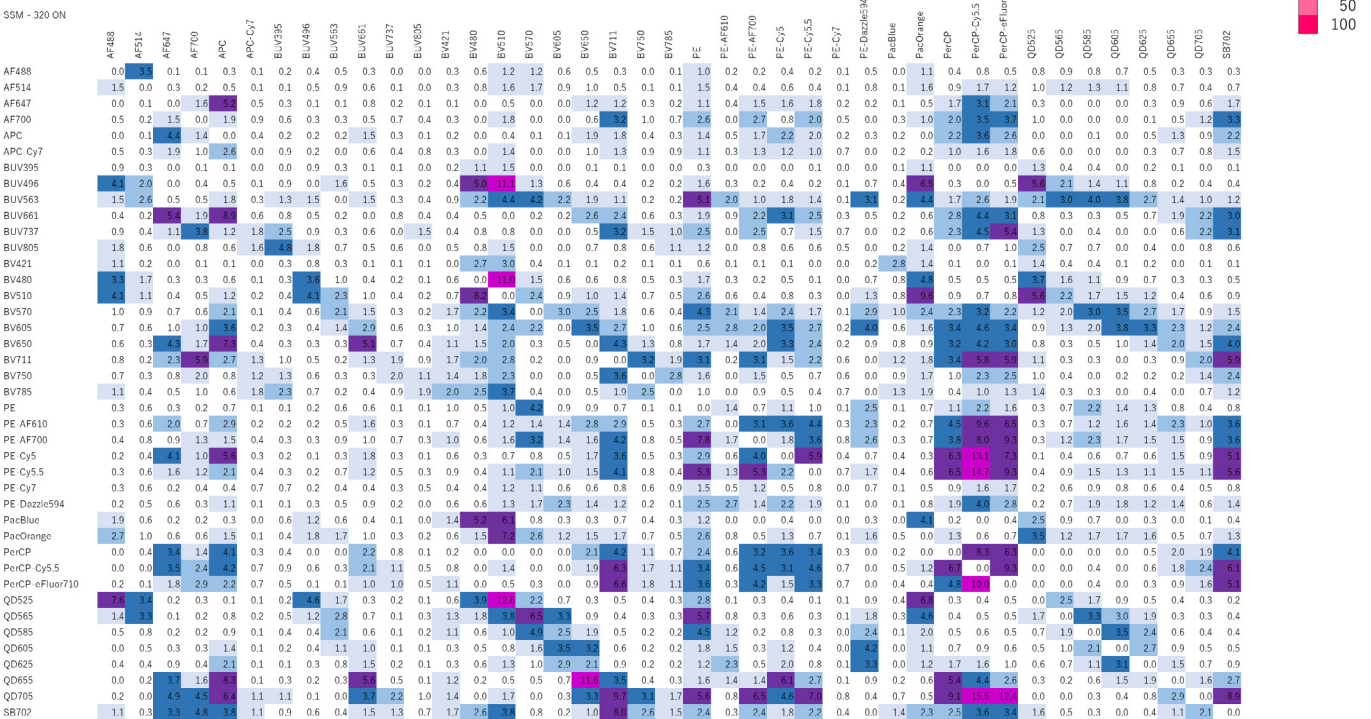
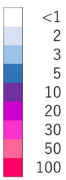
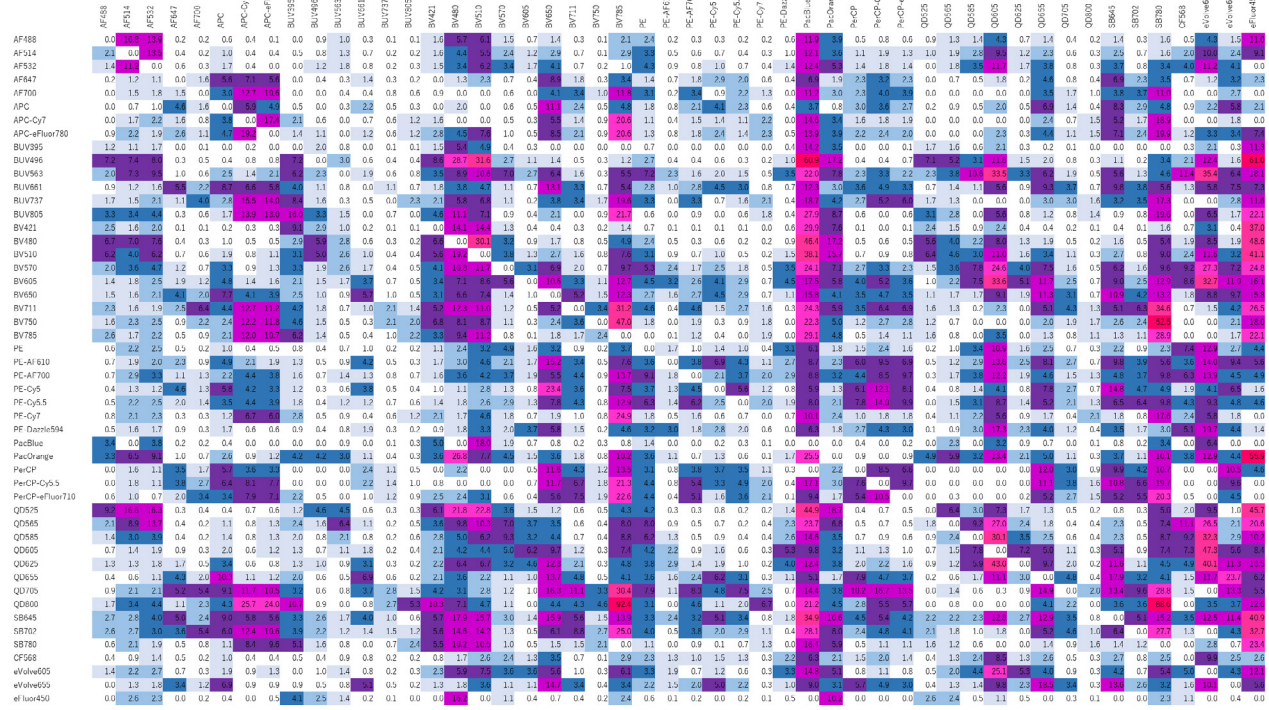

Figure 3. Spillover spread matrix for 41 colors without (A) and with (B) the 320-nm laser

A

SSM - 320 OFF



B

SSM - 320 ON

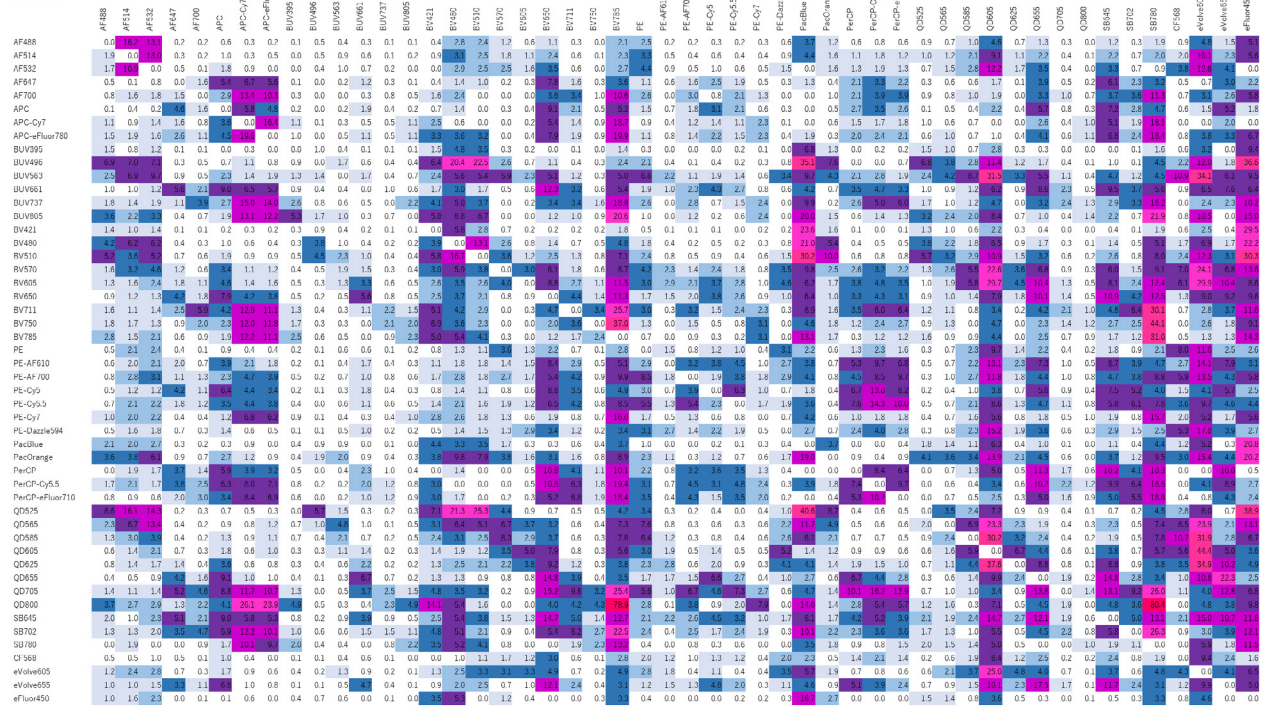

Figure 4. Spillover spread matrix for 50 colors without (A) and with (B) the 320-nm laser

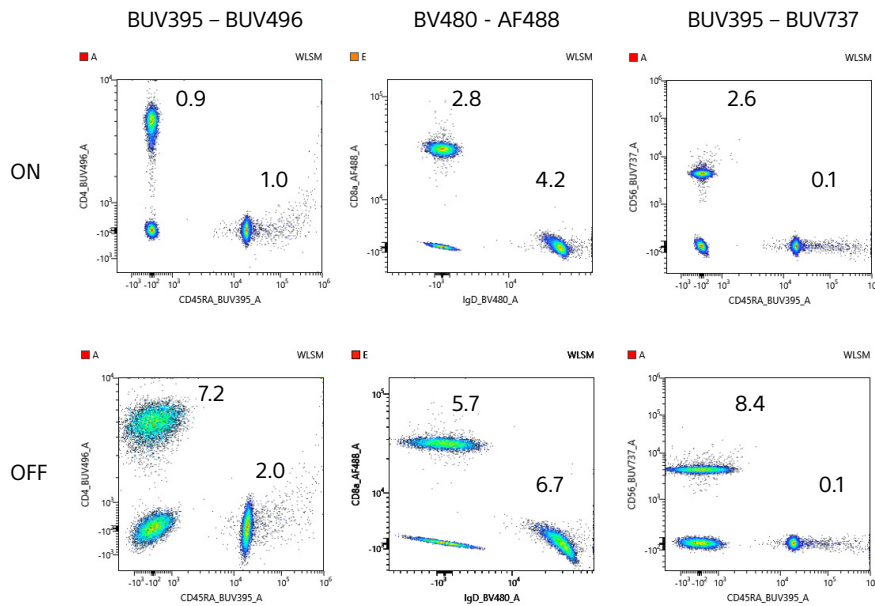

Figure 5. Examples of improvement with the 320-nm laser

Summary

The key advantage of spectral flow cytometry is the flexibility it provides for panel design for multicolor experiments. Spectral flow cytometry allows fluorochromes to be used that might be challenging to detect with non-spectral optics because of overlapping or highly adjacent emission spectra. Analysis of the separation of adjacent fluorochromes was carried out with the 320-nm laser to compare the signal-to-noise ratio after spectral unmixing and evaluate the ability of the 320-nm laser to separate individual fluorochrome signals in a multicolor experiment.

Experimental results show the ability to distinguish populations when using spectrally similar fluorochromes is improved by the 320-nm laser because the emission signals from the 320-nm laser excitation contribute additional information to improve spectral unmixing results.

References

Telford WG, Stickland L, Koschorreck M. Ultraviolet 320 nm laser excitation for flow cytometry. *Cytometry A*. 2017;91:314-325. [Pub Med](#)

Nguyen R, Perfetto S, Mahnke YD, Chattopadhyay P, Roederer M. Quantifying spillover spreading for comparing instrument performance and aiding in multicolor panel design. *Cytometry A*. 2013;83: 306-315. [Pub Med](#)