

Equipped with the Global Shutter Polarization CMOS Sensor
GigE Vision

XCG-CP510 (B/W) NEW

SDK for Polarization Camera (for Windows)

XPL-SDKW NEW

GigE Vision	Progressive Scan	2/3 Type GS CMOS	Square Pixels	C Lens Mount	5.1 MP Output	IEEE 1588	Area Gain
Image Flip	Long Exposure	Normal Shutter	External Trigger Shutter	Auto Shutter	Bulk Trigger	Sequential Trigger	Burst Trigger
Freeset Sequence	Trigger range	Partial Scan	Shading Correction	Temperature Readout	Defect Correction	B/W	

Connection Diagram P59



Polarsens

Pregius

Exmor

GIGAVISION

PoE support

Outline

XCG-CP510 is innovative camera incorporating the newly developed 5.1 MP global shutter pixel-level polarization CMOS sensor. The On-Chip Polarizer features a four-directional polarizer formed on the photodiode of the image sensor which allows the detection of linear angles of polarized light. Combined with a unique SDK (XPL-SDKW), developed to facilitate the polarization process, users can easily enable contrast enhancement, object recognition, scratch detection, reflection removal, and stress and distortion inspection.

Features

- Capture a polarized image with one shot
Each individual pixel has one of four different linear polarization filters which enables four different polarization images to be captured simultaneously. Each calculation unit composed of four-pixel block supports calculation of "Polarization directions" and "Degree of Polarization (DoP)" based on luminance value on each pixel.
- Feature-rich
The SDK for polarization camera enables the following polarized image processing.
 - Degree of Polarization (DoP)
 - Polarization Direction (Surface Normal)
 - Reflection Removal • Reflection Enhancement
 - Stress, Distortion (Retardation)
- Work efficiency
The SDK for polarization camera enables easy polarization application development. Sony provides a viewer application, library, and sample source code.

Polarization Camera & SDK for Polarization Camera

- Polarization Camera XCG-CP510
Capture four directions of the polarization. Capturing four-pixel block polarized images through linear polarizing filters (0 deg, 45 deg, 90 deg, 135 deg) without a parallax issue.

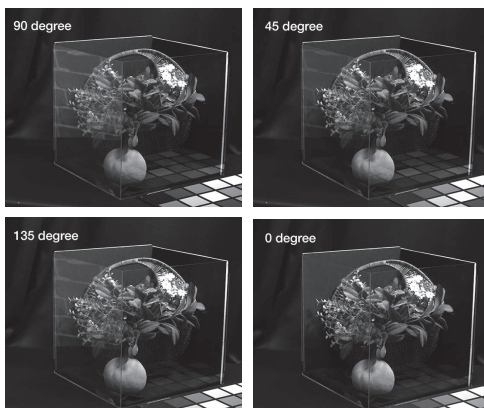
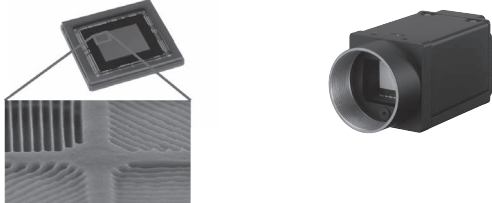

- SDK for Polarization Camera SDK XPL-SDKW (for Windows)
Process each polarization application by using polarization signals. The Windows SDK, provides versatile polarization functions such as reflection removal, shape recognition, and stress measurement by calculating polarization direction and/or Degree of Polarization (DoP) based on an image captured by the Polarization camera.

SDK for Polarization

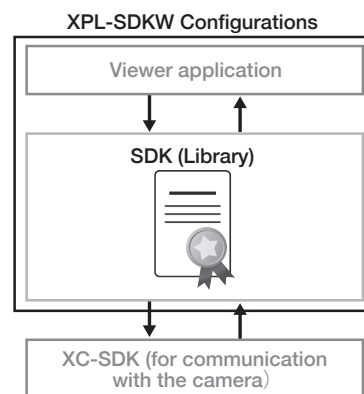

Applications of Polarization Cameras and SDK <Processing examples>

■ Degree of Polarization (DoP)

The degree of polarization (DoP) is calculated for each pixel and displayed as a degree of polarization image. This feature makes it easier to see low-contrast objects or objects that are difficult to recognize when they are the same color as the background.

Sample Images
→ See page 6

■ Direction of Polarization (Surface Normal)

The plane direction is estimated from the polarized state of each pixel and displayed as a surface normal image. The object plane direction is divided into separate colors for an easy to differentiate display.

■ Retardation

This indicates the direction and whether or not there is any distortion when light passing through the polarizing plate has passed through a transparent or semitransparent object. The measurement is effective for checking the distortion when passing through transparent or semitransparent objects such as glass and for checking stress.

■ Reflection (Enhance)

Reflected components calculated from four direction polarized images are enhanced. Images reflected off transparent objects such as glass are enhanced when displayed. A transparent object can also be made more visible.

■ Reflection (Cancel)

Reflected components calculated from four direction polarized images are removed. Images reflected off transparent objects such as glass are reduced, making objects on the other side more visible. Reflections can be removed by both automatic calculation and manual angle adjustment.

■ Demosaic

Our unique demosaic function is optimally designed for the polarizer array. All polarization processing on this SDK applies demosaic processing to calculate and display images.

■ Online/offline support

Both online operation and offline operation are supported. Online displays images and performs polarization processing live, and offline performs polarization processing when saved image files are opened.

■ FFC (Flat Field Correction)

FFC processing uses two reference images (gray and dark) to make the brightness of the recorded image uniform. Attach a lens to the polarization camera, capture gray and dark images to save as calibration files, then load them when adjustments are necessary. FFC processing can be used for post-processing without having to use the polarization camera's shading correction.

Screen Configuration <SDK for Polarization Camera XPL-SDKW>

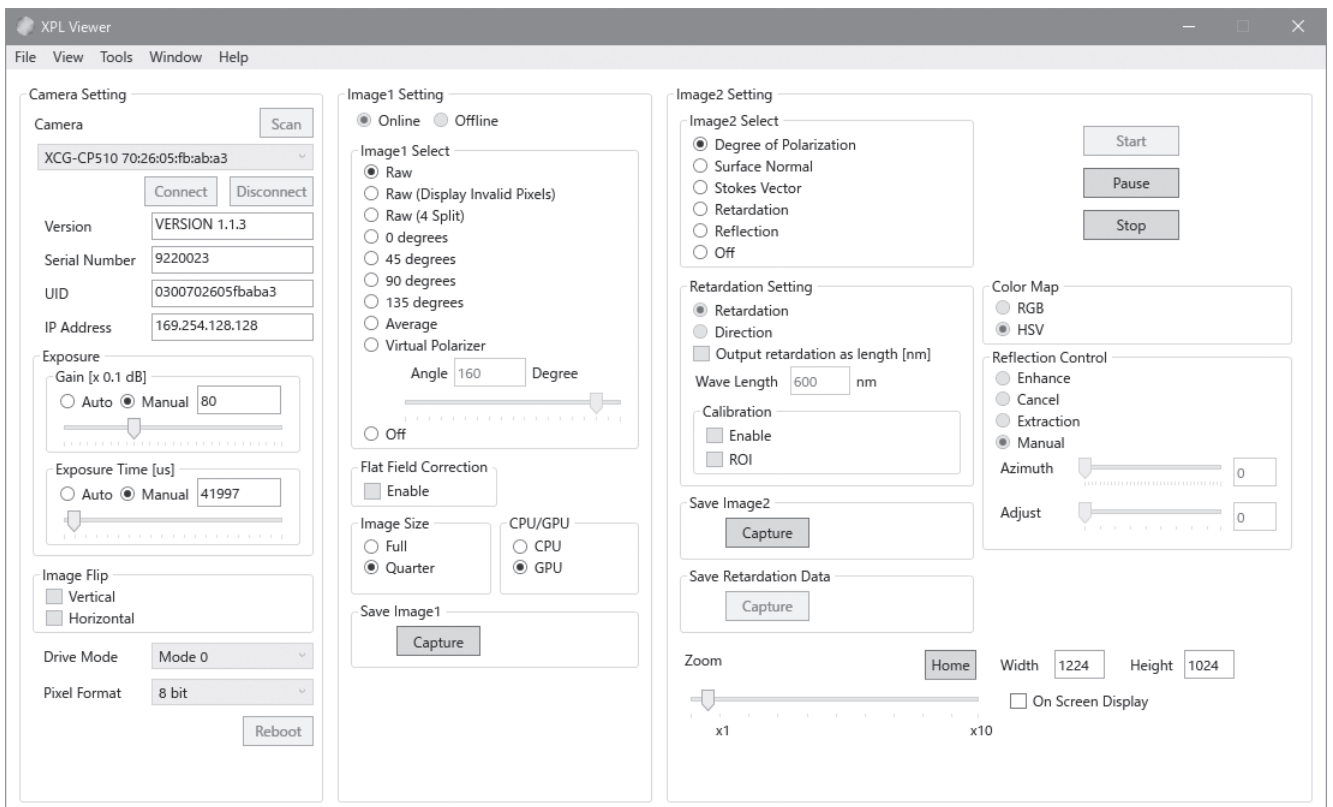

* Information on the screen is subject to change without notice

Accessories

- Compact camera adaptor : DC-700/700GE
- Tripod adaptor : VCT-333I

Dimensions

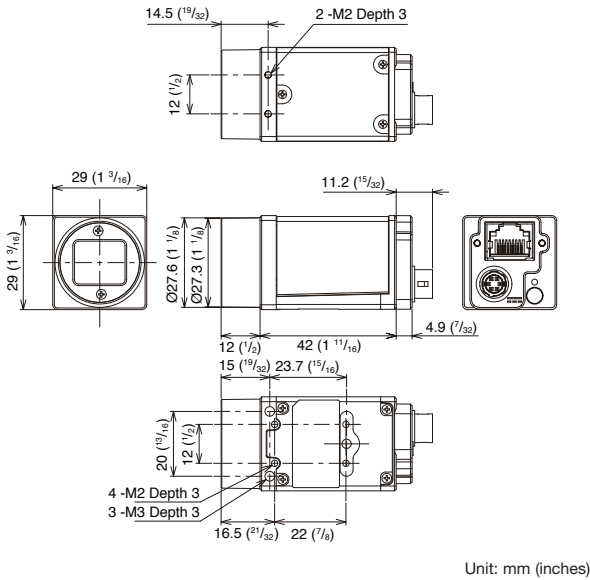

Specifications (SDK for Polarization Camera)

XPL-SDKW	
Development language	C++ / C#
Development environment	Microsoft Visual Studio 2015, 2017
Functions	Degree of Polarization, Surface Normal, Stokes Vector, Retardation, Reflection, Online/offline support, FFC (Flat Field Correction)
Configurations	Sample viewer application, Sample code, Library
Licensing	PC license
Recommended PC specs	
OS	Windows 7/8.1/10 (64bit)
CPU	Intel Core i7
Memory	16 GB or more
GPU	NVIDIA GeForce GTX1070 or above
Video RAM	8 GB or more
HDD/SDD	SSD 250 GB or more

Camera Functions

- IEEE1588 compliant → See page 8
This precision clock synchronization via network protocol conforms to the defined IEEE1588 standard.
This unit can synchronize the exposures of multiple cameras via an Ethernet cable.
- Area Gain → See page 10
You can set the individual digital gain (0 to 32times) to 16 optional rectangular areas. In the case that multiple rectangular areas overlap, the gain value with the smaller area number will have priority.
The image can be optimized to suit the subject (part), in applications such as part inspection.
- Defect Correction → See page 11
This function is useful for applications that require high resolution.
It corrects clear defect points and opaque defect points of the image sensor.
It can also correct any white or black flecks that may appear in the image due to factors such as cosmic rays. From the peripheral pixels, correction is performed on coordinate pixels in which defects are detected.
Factory setting and user setting can be selected.
* Factory setting :ON
- Shading Correction → See page 11
Depending on the characteristic of the lens, shadings caused by a drop in the amount of light around the lens, or light source variation, are corrected.
XCG-CP510 : 9 patterns
- Image Flip
You can flip the image vertically or horizontally, or rotate it 180 degrees.
- Temperature Readout
- Special Trigger modes
(Bulk trigger/Sequential trigger/Burst trigger/FreesetSequence)
- Trigger Range Limit
- GigE Vision® Version2.0/1.2
- PoE (Power over Ethernet)
- Mass : 65 g

Specifications (Polarization Camera)

XCG-CP510		
Basic specifications		
Image type	B/W	
Image size	5.1 MP	
Image sensor	IMX250 (Polarization image sensor) 2/3-type CMOS Image sensors with a global shutter function (Pregius)	
Number of effective pixels (H x V)	2,464 x 2,056	
Cell size (H x V)	3.45 μm x 3.45 μm	
Standard output pixels (H x V)	2,448 x 2,048	
Frame rate	23 fps (8 bit, Mono/Raw)	
Minimum illumination	1.5 lx (iris: F1.4, Gain: +18 dB, Shutter: 1/23 s)	
Sensitivity	F4 (400 lx, Gain: 0 dB, Shutter: 1/23 s)	
SNR	More than 50 dB (Lens close, Gain: 0 dB, 8 bit)	
Gain	Auto, Manual : 0 dB to 18 dB	
Shutter speed	Auto, Manual : 60 to 1/100,000 s	
Camera Features		
Readout modes	Normal, Partial scan	
Readout features	Test pattern	
Synchronization	Hardware trigger, Software trigger, PTP (IEEE1588)	
Trigger modes	OFF (Free run), On (trigger edge detection, trigger width detection), special trigger (burst/bulk/sequential/freeset sequence)	
User Set/Memory channel	16 channels	
User memory	64 bytes x 16 ch	
Partial scan	W (Pixel)	16 to 2,464
	H (Line)	16 to 2,056
GPO	EXPOSURE/Strobe/Sensor readout/Trigger through/Pulse generation signal/User definition 1, 2, 3 (Selectable)	
Other features	Area gain, Shading correction, Defect correction, Temperature readout	
Interface		
Video data output	digital Mono 8, 10, 12 bit (default setting 8 bit)	
Digital interface	Gigabit Ethernet (1000BASE-T/100BASE-TX)	
Camera specification	GigE Vision® Version 2.0, 1.2	
Digital I/O	ISO IN (x1), TTL IN/OUT (x2, selectable)	
General		
Lens mount	C-mount	
Flange focal length	17.526 mm	
Power requirements	DC +12 V (10.5 V to 15.0 V), IEEE802.3af (37 V to 57 V)	
Power consumption	DC+12V 3.3 W (max.)	
	IEEE802.3af 3.7 W (max.)	
Operating temperature	-5°C to +45°C (23 °F to 113 °F)	
Performance guarantee temperature	0°C to 40°C (32 °F to 104 °F)	
Storage temperature	-30°C to +60°C (-22 °F to +140 °F)	
Operating humidity	20% to 80% (no condensation)	
Storage humidity	20% to 80% (no condensation)	
Vibration resistance	10 G (20 Hz to 200 Hz, 20 minutes for each direction-x, y, z)	
Shock resistance	70 G	
Dimensions (W x H x D)	29 x 29 x 42 mm (1 3/16 x 1 3/16 x 1 11/16 inches) (excluding protrusions)	
Mass	Approx 65 g (2 oz)	
MTBF	62,042 hours (Approx. 7.1 years)	
Regulations	UL60950-1, FCC Class A, CSA C22.2-No.60950-1, IC Class A Digital Device, CE : EN61326 (Class A), AS EMC: EN61326-1, VCCI Class A, KCC, CISPR22/24+IEC61000-3-2/-3	
Supplied accessories	Lens mount cap (1), Safety Regulations*1 (1)	

*1 Safety Regulations : It describes the safety precaution. Those contents which had described in Operation Manual are aggregated in the Technical Manual.

Spectral Sensitivity Characteristics

• XCG-CP510

(Lens characteristics and light source characteristics excluded.)

Relative sensitivity

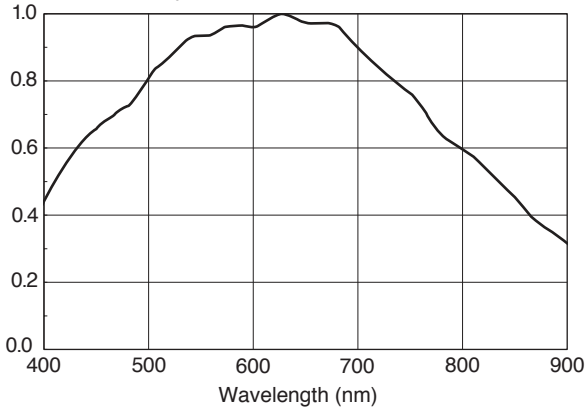

Location and Function of Parts and Controls

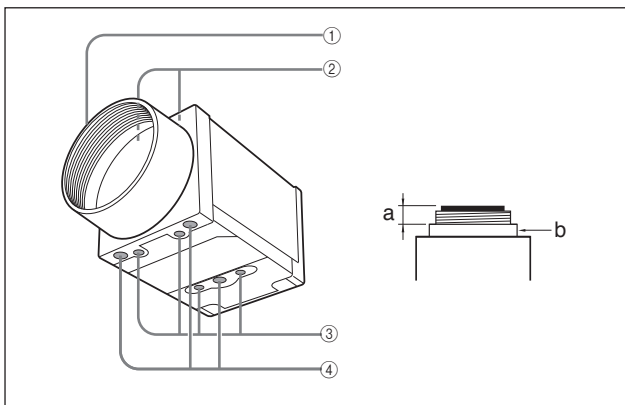

① Lens mount (C-mount)

Attach any C-mount lens or other optical equipment.

Note

Use a C-mount lens with a protrusion (a) extending from the lens mount face (b) of 10 mm (13/32 inch) or less.

② Guide screw holes (Top)

③ Guide screw holes/Tripod screw holes (bottom)

When using a tripod, use these four screw holes to attach a VCT-3331 tripod adaptor.

④ Reference screw holes (bottom)

These precision screw holes are for locking the camera module. Locking the camera module into these holes secures the optical axis alignment.

Rear Panel/Pin Assignments

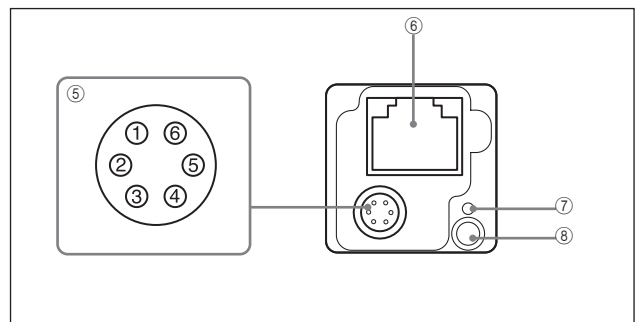

⑤ DC IN (DC power input) connector (6-pin)

You can connect a camera cable to input the +12 V DC power supply. The pin configuration of this connector is as follows. (Refer to Fig. 6 above for the pin assignment of the connector.)

Pin No.	Signal	Pin No.	Signal
1	DC input (10.5 V to 15 V)	4	GPI3/GPO3 (GPO3 (ISO +*))
2	GPI1 (ISO +)	5	GPI1 (ISO -)
3	GPI2/GPO2	6	GND

* only XCG-CG160/CG160C

⑥ RJ45 connector

You can connect a LAN cable to this connector to control the camera module from a host device to output image to a host device. By using a PoE-compatible LAN cable and camera module interface board or hub, you can supply power using the LAN cable.

Note

For safety, do not connect the connector for peripheral device wiring that might have excessive voltage to this port.

⑦ Reset switch

The camera can be reset to the factory setting by pressing the reset switch for more than 3 seconds while the power is turned on.

⑧ Status LED (Green)

This button is lit when power is being supplied to the camera. Various settings linked with GPO are available, such as to light up when interlocking with the trigger signal.

This button blinks when the network is disconnected, or while 1P is being acquired.

Connecting the Cables

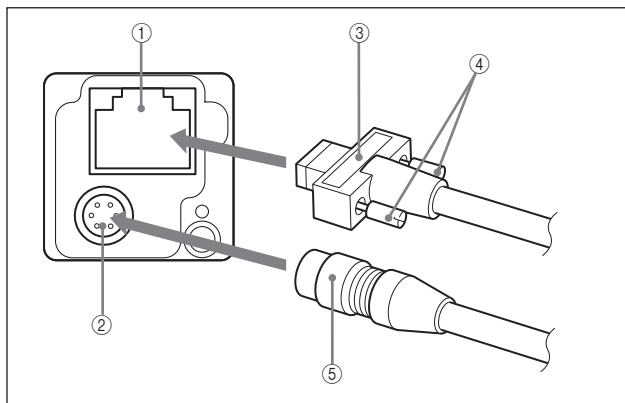

Connect the camera cable to the DC IN connector and connect the LAN cable to the RJ45 connector respectively. If you use a camera module interface board or a hub that supports PoE, you can operate the camera even if you do not connect the camera cable to the DC IN connector. When you connect the LAN cable with fastening screws, turn the two screws on the connector to secure the cable tightly.

Connect the other end of the camera cable to the DC-700/700CE and the other end of the LAN cable to the camera module interface board or a hub.

- ① RJ45 connector ② DC IN connector ③ LAN cable
④ Fastening screws ⑤ Camera cable

Note

Do not supply power to the camera cable and LAN cable at the same time.

Controlling the Camera From the Host Device

Control functions	Description	
Operating mode	Free run/Trigger	
	Free run	1/100,000 s to 60 s
	Trigger edge detection	1/100,000 s to 60 s
	Trigger pulse width detection	Setting by trigger pulse width
Gain	0 dB to 18 dB	
Partial Scan	Variable, 4-line increments (the number of settable lines are 16 or more)	
LUT (Look Up Table)	OFF/ON (Mode: 5 types)	
External trigger input	DC IN connector	
Video output switch	Monochrome model: Mono 8 / 10 / 12 bit	
Defect correction	OFF/ON	
Shading correction	OFF/ON	
Image flip	OFF/ON	
Area gain	OFF/ON	

Trigger Signal Input

Trigger signals can be input via the 2nd, 3rd, 4th pins of the DC IN connector, or the software command. Switchover of the trigger signal can be changed via the TriggerSource register.

Register	Parameter	Setting
Trigger Source	Line1 (0)	DC IN connector 2nd pin (GPI1)
	Line2 (1)	DC IN connector 3rd pin (GPI2)
	Line3 (2)	DC IN connector 4th pin (GPI3) *
	Software (4)	Software (TriggerSoftware register)
	FreeSetSequence (13)	FreeSetSequence mode
	PTP (15)	IEEE1588 synchronization mode

* XCG-CG160/CG160C: Unavailable. Dedicated to output.

Trigger signal polarity

Positive refers to a trigger signal polarity activated while rising from Low to Hi, or during the Hi interval.

Negative refers to a trigger signal polarity activated while falling from Hi to Low, or during the Low interval.

Register	Parameter	Setting
Trigger Activation	FallingEdge (0)	Negative
	RisingEdge (1)	Positive

DC IN connector specifications

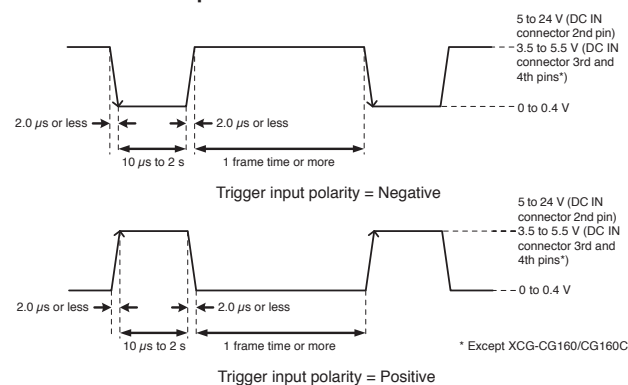

Note

- When inputting a trigger signal to the camera using the DC-700/CE, use DC 5 V or less at the logical high level.
- Make sure to supply power to the camera module and confirm that the camera module is operating before inputting a trigger signal. If you input trigger signal to a camera module without the power supplied, this may cause a malfunction of the camera module.

Trigger Signal Specifications

Trigger input polarity = Positive

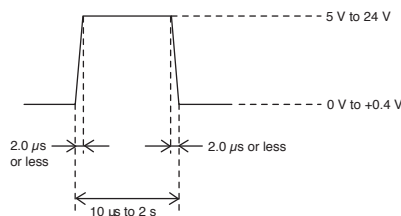

Trigger input polarity = Negative

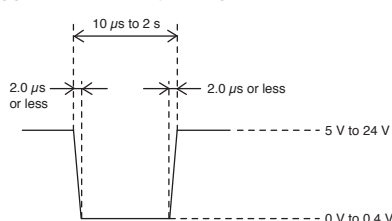

Voltage reading shows figure by terminal with 10 kΩ or more.

Note

When inputting a trigger signal to the camera using the DC-700/DC-700CE, use DC 5 V or less at the logical high level.

Trigger Modes

There are five modes, Free run, Bulk Trigger, Sequential Trigger, Burst Trigger and Freeset sequence.

Free Run

The camera operates without a trigger signal and performs the video output operation continuously after the shutter (exposure) is finished when operating in Free run mode.

- Trigger edge detection (Polarity: positive)



- Trigger width detection (Polarity: positive)

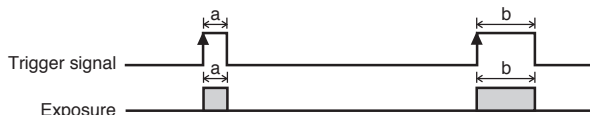

Bulk Trigger

Different camera setting configurations are stored in memory channels beforehand, with the different settings applied to acquire multiple video images at each trigger event. In the following diagram, two images are acquired in one cycle.

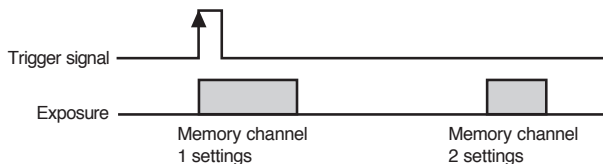

Sequential Trigger

Different camera setting configurations are stored in memory channels beforehand, with the different settings applied in sequence to acquire a different image with each trigger event. In the following diagram, two images with different exposure settings are acquired in one cycle.

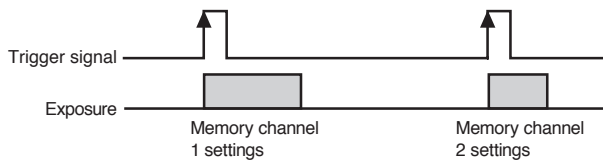

Burst Trigger

This is a feature capable of continuous shooting at the trigger timing and specifying the number of exposures, exposure interval, and exposure time. Select from the mode that repeats one exposure time or the mode that switches between 2 exposure times repeatedly. Furthermore, there is another mode that repeats only while the trigger signal is on.

(A) When 1 pattern of exposure time is set

Set the number of exposures, exposure interval (1), and exposure time (2) Continuous shooting at the trigger timing

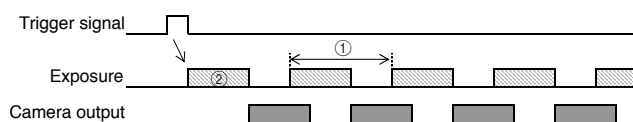

(B) When 2 patterns of exposure times are set

Set the number of exposures, exposure interval (1), and exposure time (2) Continuous shooting at the trigger timing

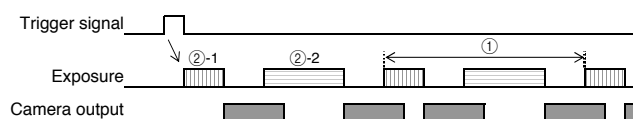

Freeset sequence

You can perform multiple (maximum 10 patterns) exposure and GPO output with 1 trigger signal.

The start time and length as well as the gain of exposure and GPO output can be set to any value.

The set sequence of exposure and GPO output is established as 1 cycle, and this cycle can be repeated.

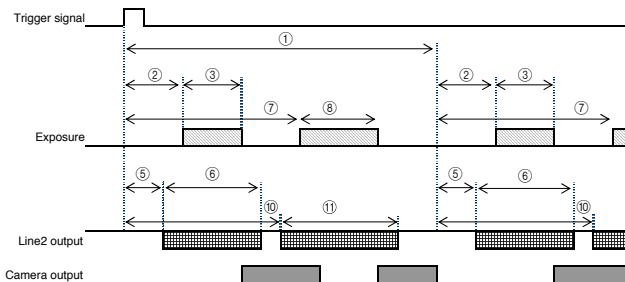

Trigger Inhibition

Trigger input can be disabled. This function is effective when disabling the trigger signal to a specific camera in the environment where multiple cameras are connected by the same trigger signal and when preventing false operations caused by noise contamination to the trigger signal line (due to the installed environment).

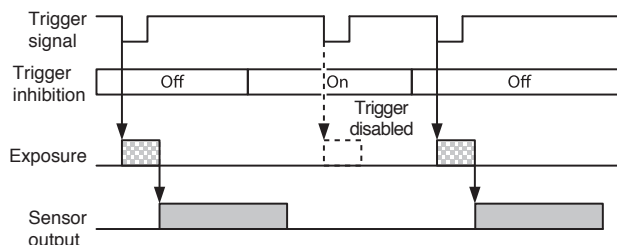

Trigger Delay

The camera can delay the trigger signal.

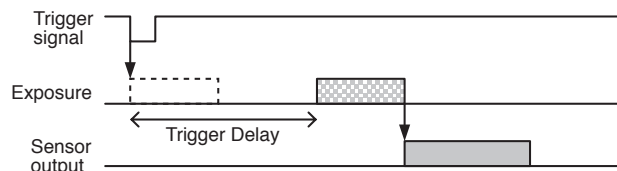

Trigger Range Limit

Only signals in the set trigger width can be accepted as the trigger signal. This functions as a noise filter, which removes chattering or disturbance noise in the trigger signal line. When the trigger signal is input, exposure is started with the time lag of the trigger range setting values. Image will not be output, when trigger signal width is out of set range.

Trigger range operation example

ExposureTime=300, TriggerAcceptanceRangeLowerLimit=100 in the figure.

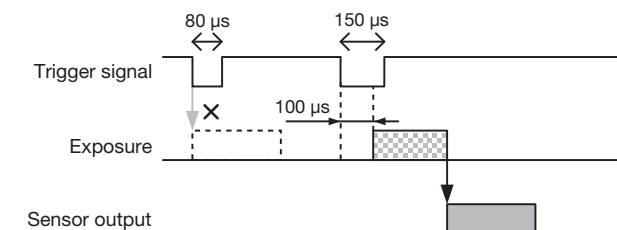

Overlap trigger

The trigger signals can be accepted during the sensor readout signals are asserted.

If the trigger cycle overs the maximum value of the frame rate, images are distorted.

Set FastTriggerMode to OFF for XCG-CG160/CG160C and XCG-CG510/CG510C.

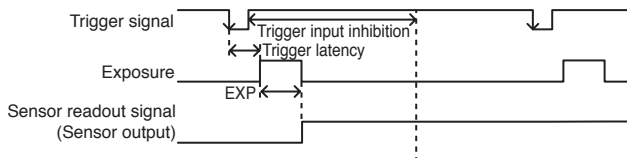

User Set

Main set values can be saved to the channels 1 to 16 of USERSET. User set is available during special trigger mode (Bulk Trigger/ Sequential Trigger).

Gain

Manual gain

The manual gain can be finely set in 0.1 dB units or bit levels. Although the settable lower/upper limit values of the gain are slightly different in each camera, the gain parameter value can be set from -1 dB or less to 27 dB or more.

Auto gain (AGC)

By setting AUTOGAIN, the gain is automatically adjusted according to the image pickup environment.

AGC works so that the average level in a detection frame may reach AGC-LEVEL. The AGC detection frame is set to the central region by default. The detection frame can be displayed or the detection area changed.

Frame Rate Control

Auto frame rate

The reading cycle is set to allow the frame rate to be the maximum value automatically according to the current shutter setting and the partial scan setting in the free-run operation (Shutter has priority). The next exposure is performed while outputting a video and the next video output is started immediately after finishing all video outputs. The frame rate is lowered when setting the shutter time longer than the video output time.

Specifying frame rate

The frame rate of the video output can be specified in the free-run operation. The value of the frame rate [fps] should be entered. The frame rate faster than the fastest frame rate cannot be set.

GPIO

GPI

The signal level which is input in the 2nd, 3rd, and 4th* DC IN connector can be detected. After selecting a connector by LineSelector register, the signal level is acquired from LineStatus register.

* Only output is available for XCG-CG160/CG160C

GPO

Various signals can be output from the 3rd and 4th DC IN connector. After selecting a connector by LineSelector register and setting LineMode to Output, LineSource is set. The output polarity is set by LineInverter register.

Register	Parameter	Setting
LineSelector	Line 1 (0)	DC IN connector 2nd pin
	Line 2 (1)	DC IN connector 3rd pin
	Line 3 (2)	DC IN connector 4th pin
LineMode	Input (0)	Set to output
	Output (1)	Input setting
LineInverter	Off (0)	Without output inversion
	On (1)	With output inversion
LineStatus		Input signal level
LineSource	TriggerThrough (0)	Trigger through signal
	ExposureActive (2)	Exposure signal
	StrobeActive (3)	Strobe control signal
	SensorReadout (4)	Sensor readout signal
	UserOutput 1 (5)	User definition 1
	UserOutput 2 (6)	User definition 2
	UserOutput 3 (7)	User definition 3
	SignalTrue (8)	Level H
	SignalFalse (9)	Level L
	PWM (10)	Pulse generation signal

Setting example:

The strobe control signal is output to GPO2 (DC IN connector 3rd pin) by Hi active setting.

LineSelector = 1
LineMode = 1
LineInverter = 0
LineSource = 3

Memory shot

Memory shot is a function that controls the exposure timing and image output to the network individually.

This is effective when multiple cameras are connected to the same network and it is necessary to expose them at the same time in a configuration that exceeds 1 Gbps band when operated simultaneously.

Memory shot is available in multi-frame mode or single-frame mode.

Number of images that can be saved is determined by image size and pixel format.

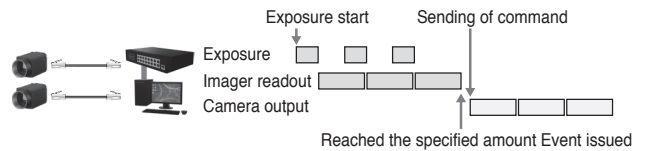

Output timing control

Normally, images are sequentially output when exposure ends, but the image output start timing can be delayed.

Optimal when requiring simultaneous exposure, but there are several cameras connected to the same network and the configuration makes the bandwidth exceed 1Gbps when operated simultaneously.

Optimal when shooting 1 shot with single frame or trigger.

