

- XCG-CG510 (B/W)**
- XCG-CG510C (Color)**
- XCG-CG240 (B/W)**
- XCG-CG240C (Color)**
- XCG-CG160 (B/W)**
- XCG-CG160C (Color)**



**Pregius** *Exmor*

**GIG VISION** **PoE**

<b>GigE Vision</b>	<b>Progressive Scan</b>	<sup>*1</sup> <b>2/3 Type GS CMOS</b>	<sup>*2</sup> <b>1/2.1 Type GS CMOS</b>	<sup>*3</sup> <b>1/2.9 Type GS CMOS</b>	<b>Square Pixels</b>	<b>C Lens Mount</b>	<sup>*1</sup> <b>5.1 MP Output</b>
<sup>*2</sup> <b>2.4 MEGA Output</b>	<sup>*3</sup> <b>1.6 MEGA Output</b>	<b>IEEE 1588</b>	<b>Area Gain</b>	<b>Image Flip</b>	<b>Long Exposure</b>	<b>Normal Shutter</b>	<b>External Trigger Shutter</b>
<b>Auto Shutter</b>	<b>Bulk Trigger</b>	<b>Sequential Trigger</b>	<b>Burst Trigger</b>	<b>Freeset Sequence</b>	<b>Trigger range</b>	<b>Partial Scan</b>	<sup>*3</sup> <b>Partial Scan Multi ROI</b>
<b>Shading Correction</b>	<b>Temperature Readout</b>	<b>Defect Correction</b>	<sup>*4</sup> <b>One-Push White Balance</b>	<sup>*4</sup> <b>Manual White Balance</b>	<b>LUT</b>	<sup>*5</sup> <b>B/W</b>	<sup>*4</sup> <b>RGB RAW</b>
<sup>*5</sup> <b>Near-IR Sensitivity</b>	Connection Diagram <b>P59</b>						

<sup>\*1</sup> : XCG-CG510/XCG-CG510C      <sup>\*4</sup> : XCG-CG510C/XCG-CG240C/XCG-CG160C  
<sup>\*2</sup> : XCG-CG240/XCG-CG240C      <sup>\*5</sup> : XCG-CG510/XCG-CG240/XCG-CG160  
<sup>\*3</sup> : XCG-CG160/XCG-CG160C

## Outline

Optimal replacement camera modules, inheriting equal size and high reliability, for CCD equipped digital and analog cameras. Responds to high speed and high sensitivity needs unique to Global Shutter CMOS, allowing use of various features.

## Features

### High frame rate

You can select either the mode that gives priority to the frame rate or one that enables the use of all functions.

Model	Priority to the frame rate Mode 0		Use of all functions Mode 1	
	XCG-CG510 XCG-CG510C	8 bit	23 fps	8/10/12 bit
			YUV422	11 fps
			RGB24	7 fps
XCG-CG240 XCG-CG240C	8 bit	41 fps	8/10/12 bit	32 fps
	10 bit	33 fps	YUV422	25 fps
			RGB24	17 fps
XCG-CG160 XCG-CG160C	8 bit	75 fps	8/10/12 bit	50 fps
			YUV422	37 fps
			RGB24	25 fps

### IEEE1588 compliant → See page 8

This precision clock synchronization via network protocol conforms to the defined IEEE1588 standard.

This unit can synchronize the exposures of multiple cameras via an Ethernet cable.

### Area Gain → See page 10

You can set the individual digital gain (0 to 32times) to 16 optional rectangular areas. In the case that multiple rectangular areas overlap, the gain value with the smaller area number will have priority. The image can be optimized to suit the subject (part), in applications such as part inspection.

### Image Flip

You can flip the image vertically or horizontally, or rotate it 180 degrees.

		ReverseX	
		0	1
ReverseY	0	Normal	Flip horizontally
	1	Flip vertically	Rotate 180 degrees

### Defect Correction → See page 11

This function is useful for applications that require high resolution.

It corrects clear defect points and opaque defect points of the image sensor.

It can also correct any white or black flecks that may appear in the image due to factors such as cosmic rays. From the peripheral pixels, correction is performed on coordinate pixels in which defects are detected.

Factory setting and user setting can be selected.

\* Factory setting :ON

### Shading Correction → See page 11

Depending on the characteristic of the lens, shadings caused by a drop in the amount of light around the lens, or light source variation, are corrected.

XCG-CG510/CG510C: 9 patterns  
 XCG-CG240/CG240C: 20 patterns  
 XCG-CG160/CG160C: 31 patterns

■ 3 x 3 filter → See page 12

Utilizing the 3 x 3 filter, you can obtain images in various processing conditions. Depending on the patterns of parameters, you can reduce noise, apply edge enhancement and extract the contour.

3 x 3 filter: OFF



Laplacian filter



■ Partial Scan

The partial scan function outputs a user-defined region (Area Of Interest) within the overall image area. The cut-out region for partial scan is defined by Offset X and Offset Y (which indicate the start point for cutting), and Width and Height (which indicate the area). Contiguous blocks of minimum areas can be selected to define regions. However, the defined region must be a square or right rectangle. T- and L-shaped regions are invalid.

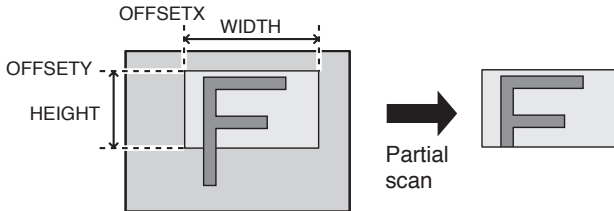

**Note**

Be aware that the frame rate increases for vertical cut-outs, while the frame rate remains unchanged for horizontal cut-outs.

■ Partial scan (Multi ROI) → See page 14 (only XCG-CG160/CG160C)

Arbitrarily read out images including any 2 (max.) rectangular area from the maximum effective imaging area. Due to this, you will be capable of limiting read out information, thus accelerating the frame rate.

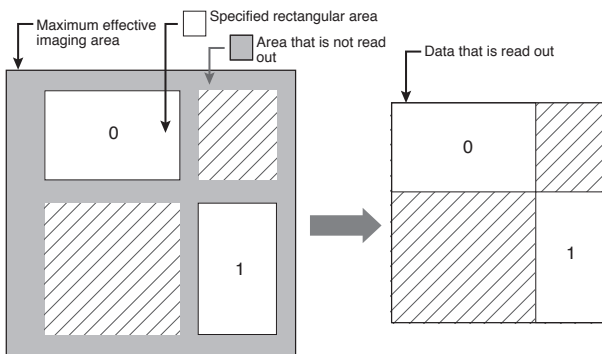

■ Binning (only XCG-CG160)

Supports binning in vertical and horizontal 2 pixel units and increases frame rate without changing the angle of view as well as enhances the sensitivity.

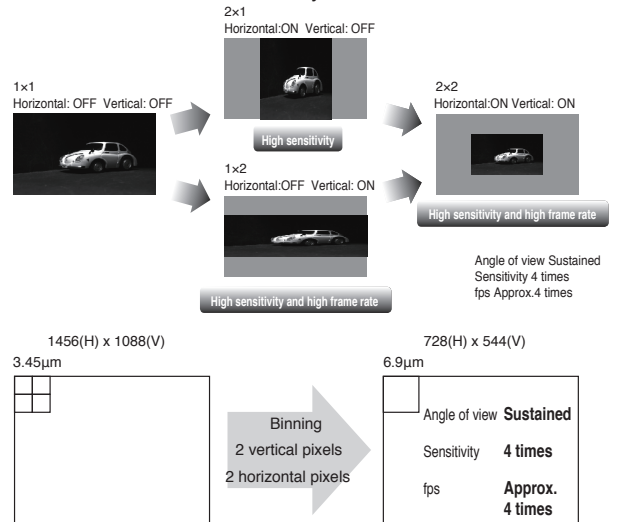

■ Temperature Readout

■ LUT (Look up Table)

■ Trigger Range Limit

■ Special Trigger modes

(Bulk trigger/Sequential trigger/Burst trigger/FreesetSequence)

■ GigE Vision® Version2.0/1.2

■ PoE (Power over Ethernet)

■ Mass : 65 g

**Pregius**

Pregius is a trademark of Sony Corporation. The Pregius is global shutter pixel technology for active pixel-type CMOS image sensors that use Sony's low-noise CCD structure, and realizes high picture quality.

**Accessories**

■ Compact camera adaptor : DC-700/700CE

■ Tripod adaptor : VCT-333I

**Dimensions**

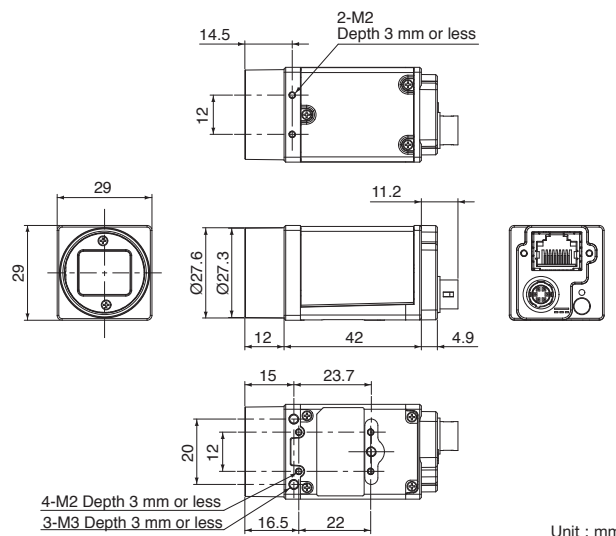

Unit : mm

# Spectral Sensitivity Characteristics

Digital Video Camera (GS CMOS) XCU XCG XCL Polarization Camera

## B/W model

### • XCG-CG510

(Lens characteristics and light source characteristics excluded.)

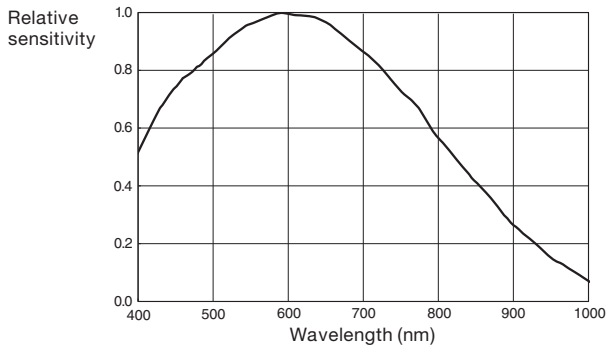

### • XCG-CG240

(Lens characteristics and light source characteristics excluded.)

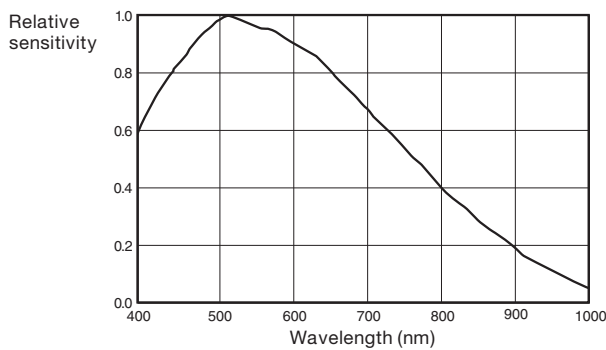

### • XCG-CG160

(Lens characteristics and light source characteristics excluded.)

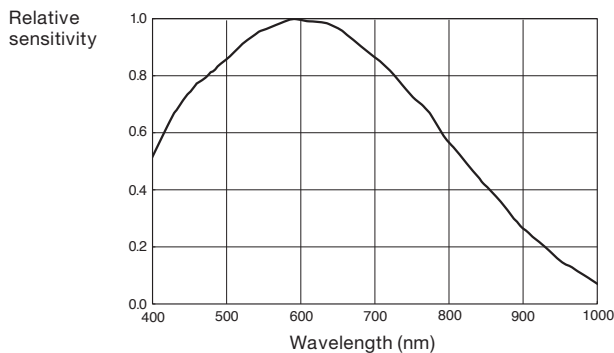

Digital Video Camera (CCD) XCL

Accessories

Color Camera Block FCB-HD FCB-4K

## Color model

### • XCG-CG510C

(Lens characteristics and light source characteristics excluded.)

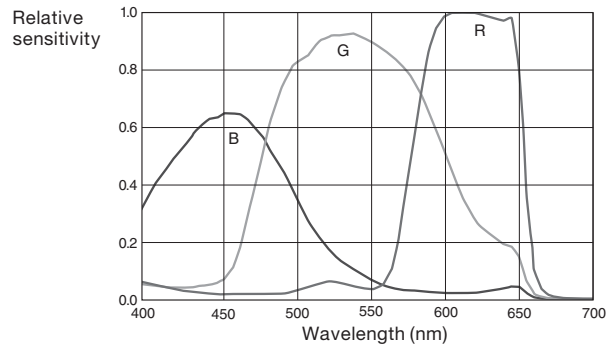

### • XCG-CG240C

(Lens characteristics and light source characteristics excluded.)

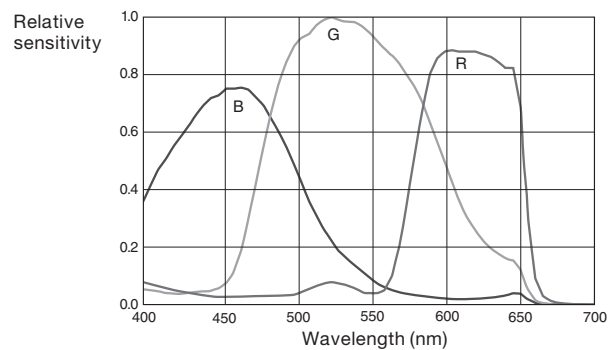

### • XCG-CG160C

(Lens characteristics and light source characteristics excluded.)

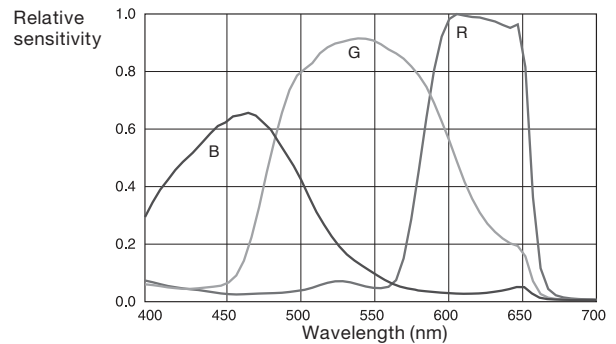

# Specifications

	XCG-CG510	XCG-CG510C	XCG-CG240	XCG-CG240C	XCG-CG160	XCG-CG160C
<b>Basic specifications</b>						
Image type	B/W Color		B/W Color		B/W Color	
Image size	5.1 MP		2.4 MP		1.6MP	
Image sensor	IMX 264 : 2/3-type Global Shutter CMOS Sensor (Pregius)		IMX 249 : 1/1.2-type Global Shutter CMOS Sensor (Pregius)		IMX 273 : 1/2.9-type Global Shutter CMOS Sensor (Pregius)	
Number of effective pixels (H x V)	2,464 x 2,056		1,936 x 1,216		1,456 x 1,088	
Cell size (H x V)	3.45 μm x 3.45 μm		5.86 μm x 5.86 μm		3.45 μm x 3.45 μm	
Standard output pixels (H x V)	2,448 x 2,048		1,920 x 1,200		1,440 x 1,080	
Color filter	—	RGB color mosaic filter	—	RGB color mosaic filter	—	RGB color mosaic filter
Frame rate	23 fps (8 bit, Mono/Raw)		41 fps (8 bit, Mono/Raw) 33 fps (10 bit, Mono/Raw)		75 fps (8 bit, Mono/Raw)	
Minimum illumination	0.5 lx (Iris: F1.4, Gain: +18 dB, Shutter: 1/23 s)	10 lx (Iris: F1.4, Gain: +18 dB, Shutter: 1/23 s)	0.5 lx (Iris: F1.4, Gain: +18 dB, Shutter: 1/30 s)	10 lx (Iris: F1.4, Gain: +18 dB, Shutter: 1/30 s)	0.5 lx (Iris: F1.4, Gain: +18 dB, Shutter: 1/30 s)	12 lx (Iris: F1.4, Gain: +18 dB, Shutter: 1/30 s)
Sensitivity	F8 (400 lx, Gain: 0 dB, Shutter: 1/23 s)	F8 (2000 lx, Gain: 0 dB, Shutter: 1/23 s)	F5.6 (400 lx, Gain: 0 dB, Shutter: 1/30 s)	F5.6 (2000 lx, Gain: 0 dB, Shutter: 1/30 s)	F5.6 (400 lx, Gain: 0 dB, Shutter: 1/30 s)	F5.6 (2000 lx, Gain: 0 dB, Shutter: 1/30 s)
SNR	More than 50 dB (Lens close, Gain: 0 dB, 8 bits)					
Gain	Auto, Manual : 0 dB to 18 dB					
Shutter speed	Auto, Manual : 60 to 1/100,000 s		Auto, Manual : 60 to 1/40,000 s		Auto, Manual : 60 to 1/100,000 s	
White balance	—	Manual, One push, Auto	—	Manual, One push, Auto	—	Manual, One push, Auto
<b>Camera Features</b>						
Readout modes	Normal, Partial scan				Normal, Bining (1x2, 2x1, 2x2), Partial scan (Multi ROI)	Normal, Partial scan (Multi ROI)
Readout features	LUT (Binarization, Gamma (arbitrary setting)), Test pattern					
Synchronization	Hardware trigger, Software trigger, PTP (IEEE1588)					
Trigger modes	OFF (Free run), On (trigger edge detection, trigger width detection), special trigger (burst/bulk/sequential/freeset sequence)					
User Set/Memory channel	16 channels					
User memory	64 bytes x 16 ch					
Partial scan	W (Pixel)	16 to 2,464		16 to 1,936		16 to 1,456
	H (Line)	16 to 2,056		16 to 1,216		16 to 1,088
GPO	EXPOSURE/Strobe/Sensor readout/Trigger through/Pulse generation signal/User definition 1, 2, 3 (Selectable)					
Other features	Area gain, Shading correction, Defect correction, Temperature readout, LUT, 3 x 3 filter					
<b>Interface</b>						
Video data output	digital Mono 8, 10, 12 bit (default setting 8 bit)	digital Raw 8, 10, 12 bit (default setting Raw 8 bit) RGB, YUV422, YUV444	digital Mono 8, 10, 12 bit (default setting 8 bit)	digital Raw 8, 10, 12 bit (default setting Raw 8 bit) RGB, YUV422, YUV444	digital Mono 8, 10, 12 bit (default setting 8 bit)	digital Raw 8, 10, 12 bit (default setting Raw 8 bit) RGB, YUV422, YUV444
Digital interface	Gigabit Ethernet (1000BASE-T/100BASE-TX)					
Camera specification	GigE Vision® Version 2.0, 1.2					
Output data clock	—					
Digital I/O	ISO IN (x1), TTL IN/OUT (x2, selectable)				ISO IN (x1), ISO OUT (x1), TTL IN/OUT (x1, selectable)	
<b>General</b>						
Lens mount	C-mount					
Flange focal length	17.526 mm					
Power requirements	DC +12 V (10.5 V to 15.0 V), IEEE802.3af (37 V to 57 V)					
Power consumption	DC+12V 3.3 W (max.)		DC+12V 3.0 W (max.)		DC+12V 3.3 W (max.)	
	IEEE802.3af 3.7 W (max.)		IEEE802.3af 3.6 W (max.)		IEEE802.3af 4.0 W (max.)	
Operating temperature	-5°C to +45°C (23 °F to 113 °F)					
Performance guarantee temperature	0°C to 40°C (32 °F to 104 °F)					
Storage temperature	-30°C to +60°C (-22 °F to +140 °F)					
Operating humidity	20% to 80% (no condensation)					
Storage humidity	20% to 80% (no condensation)					
Vibration resistance	10 G (20 Hz to 200 Hz, 20 minutes for each direction-x, y, z)					
Shock resistance	70 G					
Dimensions (W x H x D)	29 x 29 x 42 mm (1 3/16 x 1 3/16 x 1 11/16 inches) (excluding protrusions)					
Mass	Approx. 65 g (2 oz)					
MTBF	62,042 hours (Approx. 7.1 years)		63,172 hours (Approx. 7.2 years)		58,525 hours (Approx. 6.7 years)	
Regulations	UL60950-1, FCC Class A, CSA C22.2-No 60950-1, IC Class A Digital Device, CE : EN61326 (Class A), AS EMC: EN61326-1, VCCI Class A, KCC, CISPR22/24+IEC61000-3-2/3					
Supplied accessories	Lens mount cap (1), Safety Regulations *1 (1)					

\*1 Safety Regulations : It describes the safety precaution. Those contents which had described in Operation Manual are aggregated in the Technical Manual.

## Location and Function of Parts and Controls

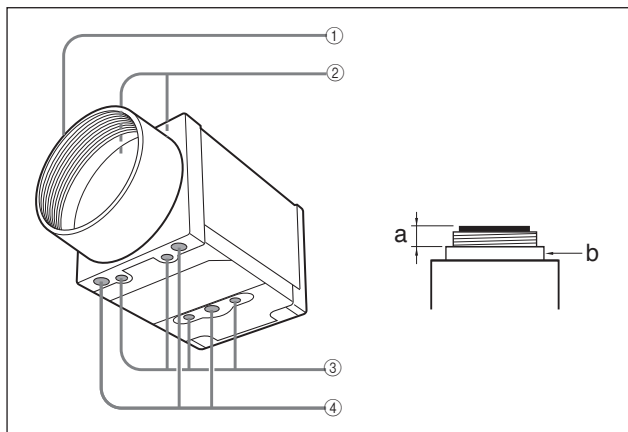

### 1 Lens mount (C-mount)

Attach any C-mount lens or other optical equipment.

#### Note

Use a C-mount lens with a protrusion (a) extending from the lens mount face (b) of 10 mm (13/32 inch) or less.

### 2 Guide screw holes (Top)

### 3 Guide screw holes/Tripod screw holes (bottom)

When using a tripod, use these four screw holes to attach a VCT-333I tripod adaptor.

### 4 Reference screw holes (bottom)

These precision screw holes are for locking the camera module. Locking the camera module into these holes secures the optical axis alignment.

## Rear Panel/Pin Assignments

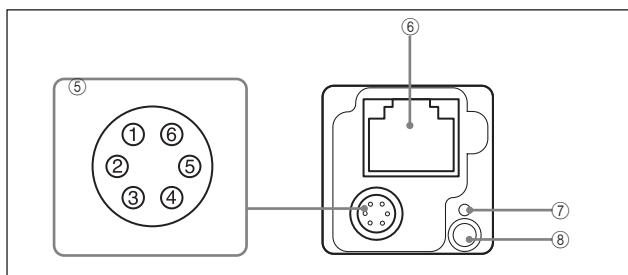

### 5 DC IN (DC power input) connector (6-pin)

You can connect a camera cable to input the +12 V DC power supply. The pin configuration of this connector is as follows. (Refer to Fig. 6 above for the pin assignment of the connector.)

Pin No.	Signal	Pin No.	Signal
1	DC input (10.5 V to 15 V)	4	GPI3/GPO3 (GPO3 (ISO +)*)
2	GPI1 (ISO +)	5	GPI1 (ISO -)
3	GPI2/GPO2	6	GND

\*only XCG-CG160/CG160C

### 6 RJ45 connector

You can connect a LAN cable to this connector to control the camera module from a host device to output image to a host device. By using a PoE-compatible LAN cable and camera module interface board or hub, you can supply power using the LAN cable.

#### Note

For safety, do not connect the connector for peripheral device wiring that might have excessive voltage to this port.

### 7 Reset switch

The camera can be reset to the factory setting by pressing the reset switch for more than 3 seconds while the power is turned on.

### 8 Status LED (Green)

This button is lit when power is being supplied to the camera.

Various settings linked with GPO are available, such as to light up when interlocking with the trigger signal.

This button blinks when the network is disconnected, or while 1P is being acquired.

## Connecting the Cables

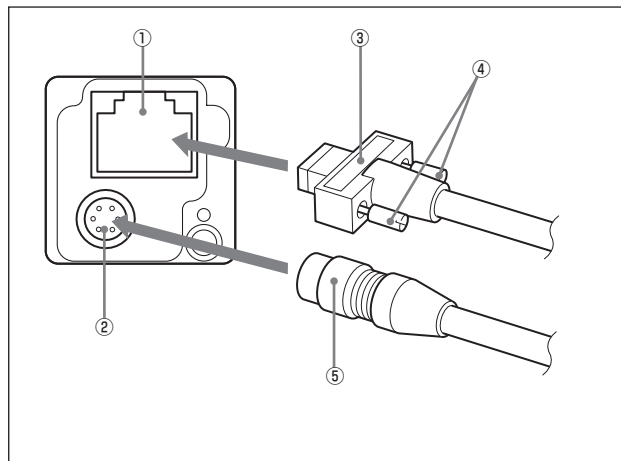

Connect the camera cable to the DC IN connector and connect the LAN cable to the RJ45 connector respectively. If you use a camera module interface board or a hub that supports PoE, you can operate the camera even if you do not connect the camera cable to the DC IN connector. When you connect the LAN cable with fastening screws, turn the two screws on the connector to secure the cable tightly.

Connect the other end of the camera cable to the DC-700/700CE and the other end of the LAN cable to the camera module interface board or a hub.

- ① RJ45 connector    ② DC IN connector    ③ LAN cable  
④ Fastening screws    ⑤ Camera cable

#### Note

Do not supply power to the camera cable and LAN cable at the same time.

## Controlling the Camera From the Host Device

Control functions	Description	
Operating mode	Free run/Trigger	
Shutter speed	Free run	1/40,000 s to 60 s (CG240)
		1/100,000 s to 60 s (CG510/CG160)
	Trigger edge detection	1/40,000 s to 60 s (CG240)
		1/100,000 s to 60 s (CG510/CG160)
Trigger pulse width detection	Setting by trigger pulse width	
Gain	0 dB to 18 dB	
Partial Scan	Variable, 4-line increments (the number of settable lines are 16 or more)	
LUT (Look Up Table)	OFF/ON (Mode: 5 types)	
External trigger input	DC IN connector	
Video output switch	Monochrome model: Mono 8 / 10 / 12 bit	
	Color model: Raw 8 / 10 / 12 bit, RGB24 bit, YUV24 bit, YUV16 bit	
Defect correction	OFF/ON	
Shading correction	OFF/ON	
Image flip	OFF/ON	
Area gain	OFF/ON	

## Trigger Signal Input

Trigger signals can be input via the 2nd, 3rd, 4th pins of the DC IN connector, or the software command. Switchover of the trigger signal can be changed via the TriggerSource register.

Register	Parameter	Setting
Trigger Source	Line1 (0)	DC IN connector 2nd pin (GPI1)
	Line2 (1)	DC IN connector 3rd pin (GPI2)
	Line3 (2)	DC IN connector 4th pin (GPI3) *
	Software (4)	Software (TriggerSoftware register)
	FreeSetSequence (13)	FreeSetSequence mode
	PTP (15)	IEEE1588 synchronization mode

\* XCG-CG160/CG160C: Unavailable. Dedicated to output.

### Trigger signal polarity

Positive refers to a trigger signal polarity activated while rising from Low to Hi, or during the Hi interval.

Negative refers to a trigger signal polarity activated while falling from Hi to Low, or during the Low interval.

Register	Parameter	Setting
Trigger Activation	FallingEdge (0)	Negative
	RisingEdge (1)	Positive

### DC IN connector specifications

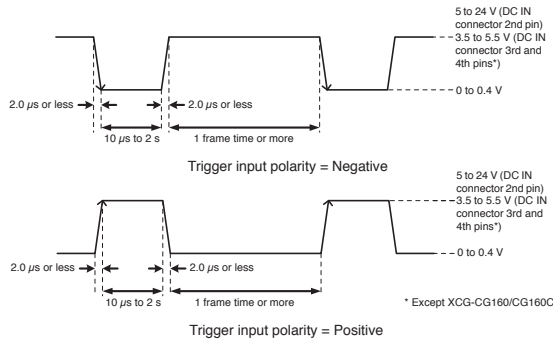

#### Note

- When inputting a trigger signal to the camera using the DC-700/CE, use DC 5 V or less at the logical high level.
- Make sure to supply power to the camera module and confirm that the camera module is operating before inputting a trigger signal. If you input trigger signal to a camera module without the power supplied, this may cause a malfunction of the camera module.

## Trigger Signal Specifications

Trigger input polarity = Positive

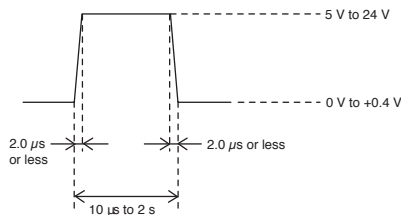

Trigger input polarity = Negative

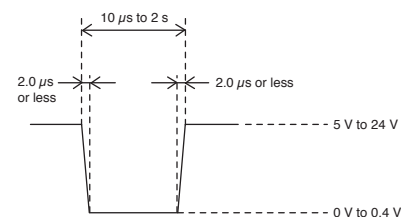

Voltage reading shows figure by terminal with 10 kΩ or more.

#### Note

When inputting a trigger signal to the camera using the DC-700/DC-700CE, use DC 5 V or less at the logical high level.

## Trigger Modes

There are five modes, Free run, Bulk Trigger, Sequential Trigger, Burst Trigger and Freeset sequence.

### Free Run

The camera operates without a trigger signal and performs the video output operation continuously after the shutter (exposure) is finished when operating in Free run mode.

- Trigger edge detection (Polarity: positive)



- Trigger width detection (Polarity: positive)

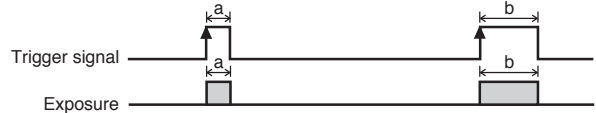

### Bulk Trigger

Different camera setting configurations are stored in memory channels beforehand, with the different settings applied to acquire multiple video images at each trigger event. In the following diagram, two images are acquired in one cycle.

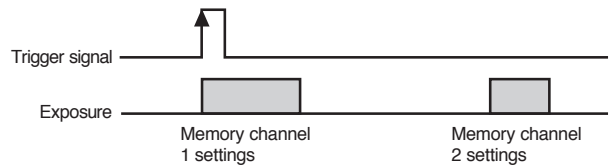

### Sequential Trigger

Different camera setting configurations are stored in memory channels beforehand, with the different settings applied in sequence to acquire a different image with each trigger event. In the following diagram, two images with different exposure settings are acquired in one cycle.

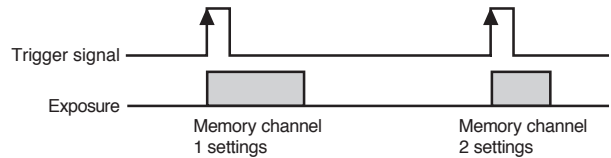

### Burst Trigger

This is a feature capable of continuous shooting at the trigger timing and specifying the number of exposures, exposure interval, and exposure time. Select from the mode that repeats one exposure time or the mode that switches between 2 exposure times repeatedly. Furthermore, there is another mode that repeats only while the trigger signal is on.

(A) When 1 pattern of exposure time is set

Set the number of exposures, exposure interval (1), and exposure time (2) Continuous shooting at the trigger timing

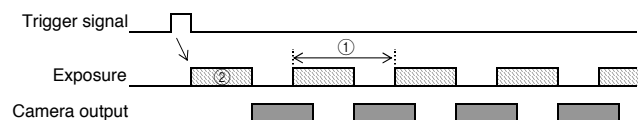

(B) When 2 patterns of exposure times are set

Set the number of exposures, exposure interval (1), and exposure time (2) Continuous shooting at the trigger timing

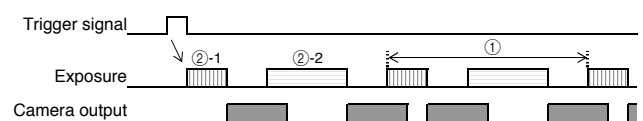

### Freerset sequence

You can perform multiple (maximum 10 patterns) exposure and GPO output with 1 trigger signal.

The start time and length as well as the gain of exposure and GPO output can be set to any value.

The set sequence of exposure and GPO output is established as 1 cycle, and this cycle can be repeated.

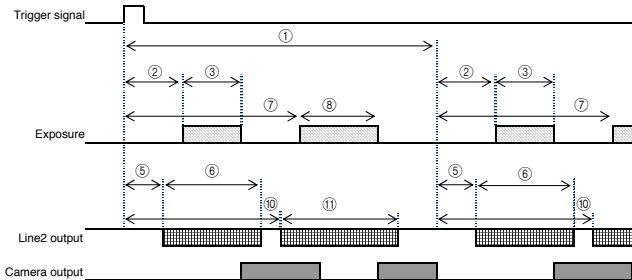

### Trigger Inhibition

Trigger input can be disabled. This function is effective when disabling the trigger signal to a specific camera in the environment where multiple cameras are connected by the same trigger signal and when preventing false operations caused by noise contamination to the trigger signal line (due to the installed environment).

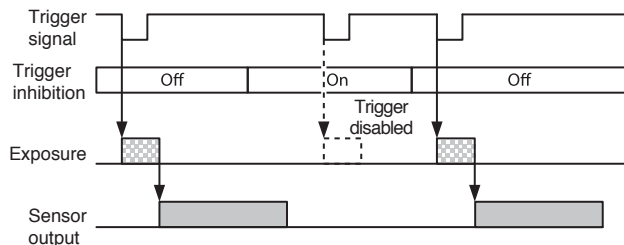

### Trigger Delay

The camera can delay the trigger signal.

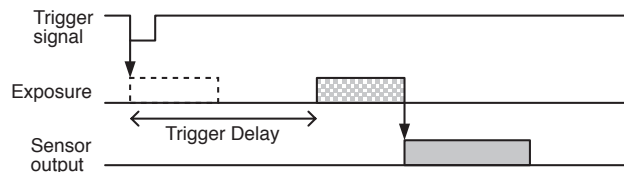

### Trigger Range Limit

Only signals in the set trigger width can be accepted as the trigger signal. This functions as a noise filter, which removes chattering or disturbance noise in the trigger signal line. When the trigger signal is input, exposure is started with the time lag of the trigger range setting values. Image will not be output, when trigger signal width is out of set range.

#### Trigger range operation example

ExposureTime=300, TriggerAcceptanceRangeLowerLimit=100 in the figure.

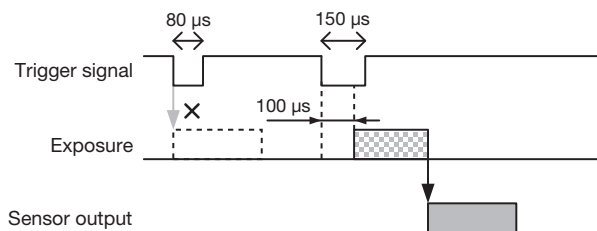

### Overlap trigger

The trigger signals can be accepted during the sensor readout signals are asserted.

If the trigger cycle overs the maximum value of the frame rate, images are distorted.

Set FastTriggerMode to OFF for XCG-CG160/CG160C and XCG-CG510/CG510C.

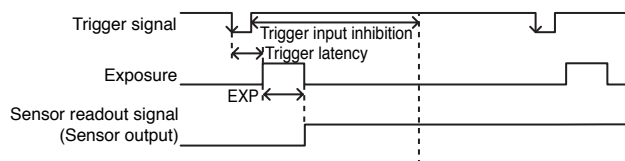

### User Set

Main set values can be saved to the channels 1 to 16 of USERSET. User set is available during special trigger mode (Bulk Trigger/ Sequential Trigger).

### Gain

#### Manual gain

The manual gain can be finely set in 0.1 dB units or bit levels. Although the settable lower/upper limit values of the gain are slightly different in each camera, the gain parameter value can be set from -1 dB or less to 27 dB or more.

#### Auto gain (AGC)

By setting AUTOGAIN, the gain is automatically adjusted according to the image pickup environment.

AGC works so that the average level in a detection frame may reach AGC-LEVEL. The AGC detection frame is set to the central region by default. The detection frame can be displayed or the detection area changed.

### Frame Rate Control

#### Auto frame rate

The reading cycle is set to allow the frame rate to be the maximum value automatically according to the current shutter setting and the partial scan setting in the free-run operation (Shutter has priority). The next exposure is performed while outputting a video and the next video output is started immediately after finishing all video outputs. The frame rate is lowered when setting the shutter time longer than the video output time.

#### Specifying frame rate

The frame rate of the video output can be specified in the free-run operation. The value of the frame rate [fps] should be entered. The frame rate faster than the fastest frame rate cannot be set.

### Look-Up Table (LUT)

The camera's look-up table consists of 4,096 values, with 12-bit input and output. The look-up table allows setting an arbitrary gamma curve or binarization. Also, a gamma curve coefficient can be specified for the standard black level. For levels below the standard black level, set the gamma value to 1 to prevent burnt-out highlights in the black level.

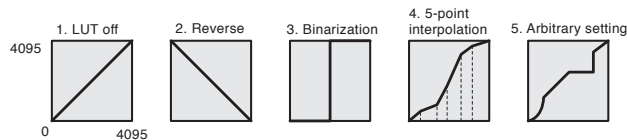

## White Balance (XCG-CG510C/CG240C/CG160C)

The white balance can be automatically adjusted when the BalanceWhiteAuto command is executed. The detection area is set to the screen center by default. The detection area can also be displayed on the screen. The detection frame can be changed arbitrarily (DetectAreaWBAuto). For manual correction, the GainDigital should be changed.

## GPIO

### GPI

The signal level which is input in the 2nd, 3rd, and 4th\* DC IN connector can be detected. After selecting a connector by LineSelector register, the signal level is acquired from LineStatus register.

\* Only output is available for XCG-CG160/CG160C

### GPO

Various signals can be output from the 3rd and 4th DC IN connector. After selecting a connector by LineSelector register and setting LineMode to Output, LineSource is set. The output polarity is set by LineInverter register.

Register	Parameter	Setting
LineSelector	Line 1 (0)	DC IN connector 2nd pin
	Line 2 (1)	DC IN connector 3rd pin
	Line 3 (2)	DC IN connector 4th pin
LineMode	Input (0)	Set to output
	Output (1)	Input setting
LineInverter	Off (0)	Without output inversion
	On (1)	With output inversion
LineStatus		Input signal level
LineSource	TriggerThrough (0)	Trigger through signal
	ExposureActive (2)	Exposure signal
	StrobeActive (3)	Strobe control signal
	SensorReadout (4)	Sensor readout signal
	UserOutput 1 (5)	User definition 1
	UserOutput 2 (6)	User definition 2
	UserOutput 3 (7)	User definition 3
	SignalTrue (8)	Level H
	SignalFalse (9)	Level L
	PWM (10)	Pulse generation signal

Setting example:

The strobe control signal is output to GPO2 (DC IN connector 3rd pin) by Hi active setting.

```
LineSelector = 1
LineMode = 1
LineInverter = 0
LineSource = 3
```

## Memory shot

Memory shot is a function that controls the exposure timing and image output to the network individually. This is effective when multiple cameras are connected to the same network and it is necessary to expose them at the same time in a configuration that exceeds 1 Gbps band when operated simultaneously.

Memory shot is available in multi-frame mode or single-frame mode.

Number of images that can be saved is determined by image size and pixel format.

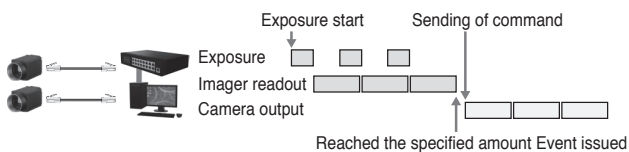

## Output timing control

Normally, images are sequentially output when exposure ends, but the image output start timing can be delayed.

Optimal when requiring simultaneous exposure, but there are several cameras connected to the same network and the configuration makes the bandwidth exceed 1Gbps when operated simultaneously.

Optimal when shooting 1 shot with single frame or trigger.

