

FCB-4K Series

**FCB-ER8550** \* With external synchronization **NEW**

**FCB-ER8530** **NEW**



**Exmor R 4K**

Outline

A new 4K camera block series featuring Sony's most advanced Exmor R™ CMOS sensor. FCB-ER8550/ER8530 is similar in size as the FCB-EV series, full HD models with 30x optical zoom, making them easily interchangeable with each other. FCB-ER8550 has an external synchronization function that allows synchronized image capturing by multiple cameras.

Features

■ **4K**  
Delivers 4 times higher resolution than Full HD (1080p). Realize a high-definition (fine) image quality that allows users to see the details of images even when viewed on a large screen and realistically reproduces textures that could not be expressed with Full HD.

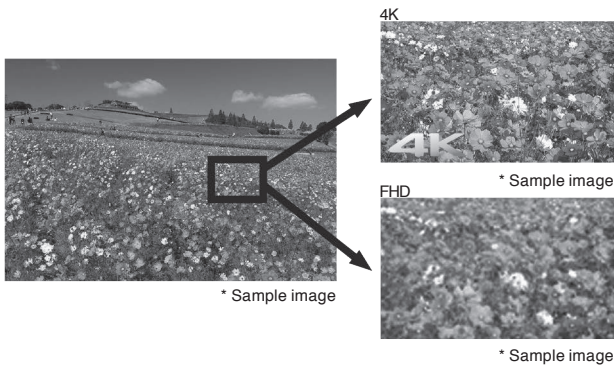

- **Optical Zoom 20x**
- **Various video outputs from 4K to SD**
- **Super Resolution Zoom**  
Delivers excellent images while maintaining the resolution without reducing image quality when the image is expanded due to the Sony unique "Full pixel super-resolution imaging technology". FCB-ER8550/ER8530 has 30x zoom, which is achieved in conjunction with optical 20x zoom.

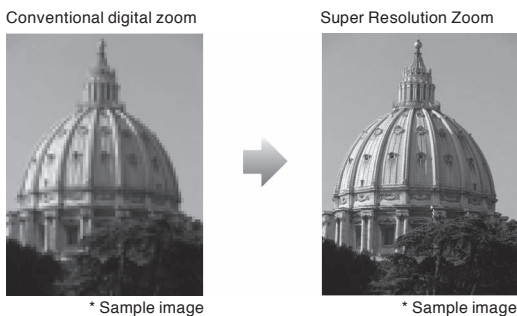

- **External Synchronization (only FCB-ER8550)**  
Prevents screen distortion when the camera image switches by synchronizing the timing of image signals including those of multiple video cameras. Also, prevents image distortion by synchronizing the timing of the image signal with other devices including LED lights.

Multiple camera configuration (example)

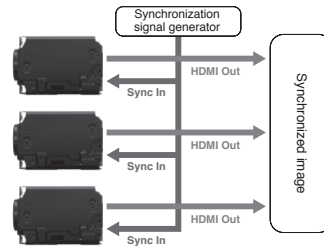

[Application] Example of sporting event analysis  
Images captured by multiple cameras are stitched together to create an image of the overall stadium. This configuration is optimal for tracking and taking statistics of athletes or analyzing events on the field of play. External synchronization can prevent noise that may occur when cameras are switched to follow an object (athletes, balls, etc.)

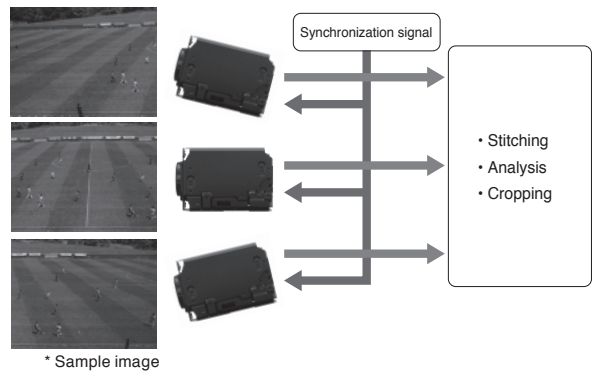

\* The parts in white frames are not displayed on the actual screen.

Digital Video Camera (GS CMOS)  
Polarization Camera  
XCU XCG XCL

Digital Video Camera (CCD)  
XCL

Accessories

Color Camera Block  
FCB-4K  
FCB-HD

■ **Visibility Enhancer (VE)**

Depending on the imaging scene, the Visibility Enhancer function makes the darker part of a camera image brighter, and automatically corrects brightness and contrast to show bright parts clearly.

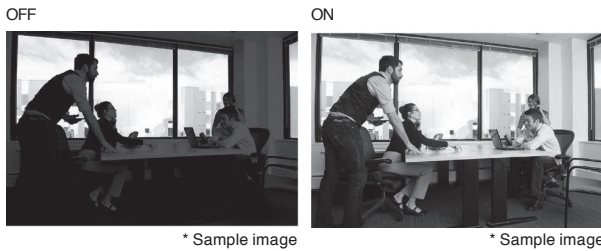

\* Sample image

\* Sample image

■ **Defog (low/mid/high)**

When the surrounding area of the subject is foggy and low contrast, the defog mode will reduce the effects of the fog and make the subject appear clearer. You can select from four levels: OFF, Low, Middle and High. The effect level can be automatically adjusted according to the fog density.



\* Sample image

\* Sample image

■ **Noise Reduction (NR)**

The NR function removes noise (both random and non-random) to provide clearer images.

■ **Privacy Zone masking**

Privacy Zone masking protects private objects and areas such as house windows, entrances, and exits which are within the camera's range of vision but not subject to surveillance. Privacy zone masking can be masked on the monitor to protect privacy.

- Mask can be displayed on 8 places per screen simultaneously.
- Individual on/off zone masking settings.

■ **Image Stabilizer**

Switching On the Image Stabilizer function reduces image blurring caused by, for example, vibration, which allows you to obtain images without much blurring. A correction effect is possible for a vibration frequency of around 10 Hz.

■ **StableZoom™**

StableZoom is a function that performs corrections in accordance with the zoom magnification by using the image stabilizer function, and zooms in an image by combining the optical zoom and electronic zoom.

■ **Picture Effect**

• **E-FLIP**

This function reverses the video output from the camera vertically and horizontally.

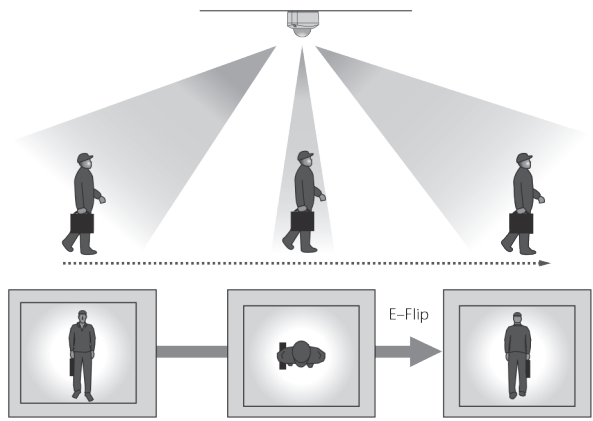

• **Freeze**

This function captures an image in the field memory of the camera so that this image can be output continuously.

• **Black & White: Monochrome Image**

■ **Auto ICR**

Auto ICR Mode automatically switches the settings needed for attaching or removing the IR Cut Filter. With a set level of darkness, the IR Cut Filter is automatically disabled (ICR On), and the infrared sensitivity is increased. With a set level of brightness, the IR Cut Filter is automatically enabled (ICR Off).

■ **Slow AE Response**

The slow AE Response function allows you to reduce the exposure response speed. Usually the camera is set up so that the optimum exposure can be obtained automatically within about 1 second.

■ **White Balance**

Various modes

- **Auto**  
This mode computes the white balance value output using color information from the entire screen.
- **ATW**  
Auto Tracing White balance
- **Indoor**
- **Outdoor**
- **Outdoor Auto**  
This is an auto white balance mode specifically for outdoors.
- **One Push WB**  
The One Push White Balance mode is a fixed white balance mode that may be automatically readjusted only at the request of the user (One Push Trigger), assuming that a white subject, in correct lighting conditions, and occupying more than 1/2 of the image, is submitted to the camera.
- **Manual WB**
- **Sodium Vapor Lamp Auto**
- **Sodium Vapor Lamp (Fix)**
- **Sodium Vapor Lamp Outdoor Auto**

# Pin Assignment (CN1701)

Pin No.	I/O	Name	Level
1	—	GND	
2	O	TMDS Clock —	
3	O	TMDS Clock +	
4	—	GND	
5	O	TMDS Data 0 —	
6	O	TMDS Data 0 +	
7	—	GND	
8	O	TMDS Data 1 —	
9	O	TMDS Data 1 +	
10	—	GND	
11	O	TMDS Data 2 —	
12	O	TMDS Data 2 +	
13	—	GND	
14	O	XSDO_ACC_LED	Only FCB-ER8550
15	I	EXT_SYNC	Only FCB-ER8550
16	O	EXT_SYNC_LOCK	Only FCB-ER8550
17	I	Hot Plug Detect	TMDS Out : 5V DC TMDS Stop : Open or GND
18	O	+ 5V Power	
19	I	USB_VBUS	USB communication active : 5V DC USB communication inActive : Open or GND
20	—	GND	
21	I/O	USB_D —	
22	I/O	USB_D +	
23	—	GND	
24	I	VISCA_RxD	CMOS 3.1V (High : Min 2.3 [V], Low : Max 1.0 [V])
25	O	VISCA_TxD	CMOS 3.1V (High : Min 2.7 [V], Low : Max 0.4 [V])
26	I	RESET	Reset operation : Low (GND) Reset cancel : Open (High Impedance)
27	I	DC IN	6 to 12 V DC
28	I	DC IN	6 to 12 V DC
29	I	DC IN	6 to 12 V DC
30	I	DC IN	6 to 12 V DC

Connector (CN1701)

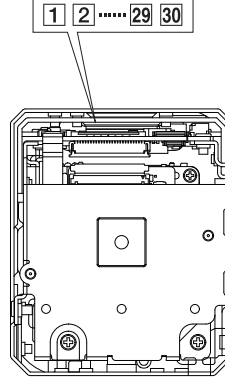

- \* It is assumed that Pin No. 18 is used as the 5 V power supply of HDMI.
  - \* When you use the USB communication, connect VBUS of the USB host to Pin No. 19.
- If you cannot prepare VBUS, connect Pin No. 18 to Pin No. 19.

# Dimensions

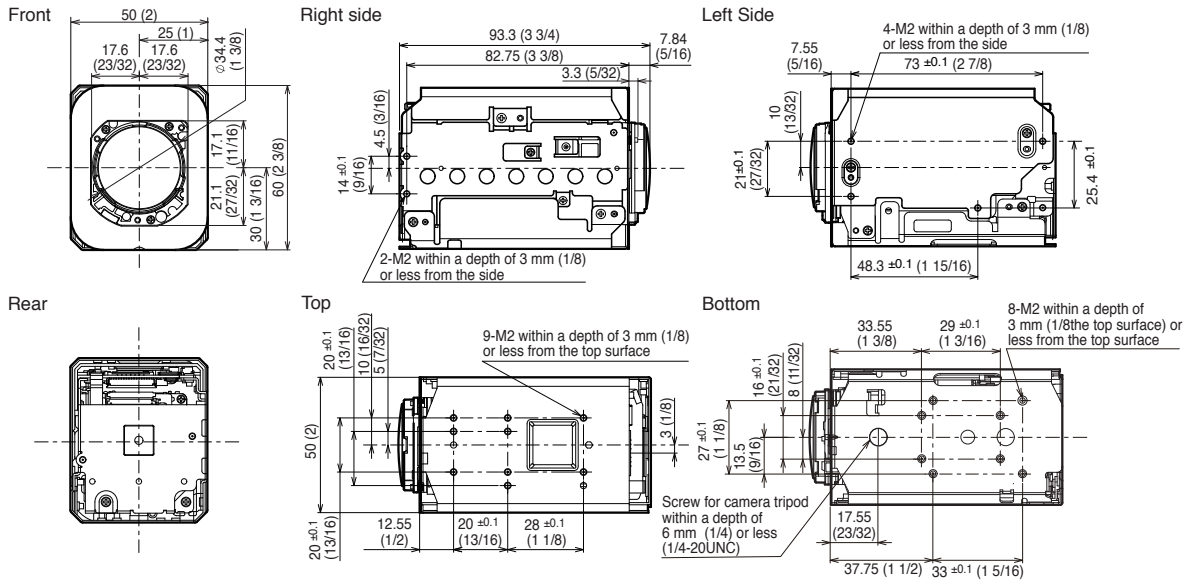

Unit: mm (inches)

# Specifications

	FCB-ER8550 With external synchronization	FCB-ER8530
<b>Basic specifications</b>		
Image Sensor (Number of effective pixels)	1/2.5-type Exmor R CMOS Sensor (8510K pixels)	
Output Pixels (H x V)	3840x2160 (QFHD), 1920x1080 (Full HD), 1280x720 (HD), 720x480/576 (SD)	
Signal System	2160p/29.97, 2160p/25, 2160p/23.98, 1080p/59.94, 1080p/50, 1080p/29.97, 1080p/25, 1080p/23.98, 1080i/59.94, 1080i/50, 720p/59.94, 720p/50, 480p/59.94, 576p/50	
Minimum Illumination (50%, High Sensitivity Mode)	0.4 lx (Shutter Speed (1/30 s)) 0.06 lx (Shutter Speed (1/4 s or 1/3 s))	
Recommended Illumination	100 lx to 100,000 lx	
SNR	50 dB	
Gain	Auto / Manual (0 dB to 48.0 dB), 0 to 16 steps	
Shutter Speed	1/1 to 1/10000 s, 22 steps	
Sync System	Internal / External	Internal
Exposure Control	0 dB to ± 10.5 dB, 15 steps	
Backlight Compensation	Yes	
Gamma	Standard / Straight gamma	
Aperture Control	16 steps	
White Balance	Auto, ATW, Indoor, Outdoor, One Push WB, Manual WB, Outdoor Auto, Sodium Vapor Lamp (Fix/Auto/Outdoor Auto)	
AE (Auto Exposure Mode)	Full Auto, Manual, Priority mode (shutter/iris), Bright, EV Compensation	
Lens	20x optical zoom, f= 4.4 mm to 88.4 mm, F2.0 to F3.8	
Zoom Mode	Standard Mode / Variable Mode / Direct Mode	
Super Resolution Zoom	QFHD: 1.5x (max. 30x with optical zoom) Full HD/HD: 2.0x (max. 40x with optical zoom)	
Digital Zoom	12x (max. 240x with optical zoom)	
<b>Zoom Movement Speed</b>		
Optical wide to Optical tele	3.0 s (Focus Tracking ON)	
Optical wide to Super resolution zoom tele	3.4 s	
Optical wide to Digital zoom tele	5.0 s	
Focusing System	Auto Focus (Normal AF, Interval AF, Zoom Trigger AF [Sensitivity:normal, low]), Manual (Standard, Variable, Direct), One Push Trigger, Near Limit, Spot Focus, IR Correction	
Focus Movement time	∞ to Near: 0.1 s	
Horizontal Viewing Angle (QFHD/Full HD/HD) (wide end to tele end)	Approx. 70.2° to 4.1° (Image stabilizer OFF) Approx. 60.0° to 3.5° (Image stabilizer ON)	
Minimum Object Distance (wide end to tele end)	80 mm to 800 mm	
<b>Camera Features</b>		
Auto ICR	Yes	
Wide Dinamic Range (Wide-D) (Auto mode)	—	
Visibility Enhancer	Yes	
Defog	Yes (low/mid/high)	
Noise Reduction	Yes (3D+2D / Independent setting (3D, 2D))	
Image Stabilization	Yes	
StableZoom **1	Yes	
Digital Output	Yes	
Spherical Privacy Zone Masking	Yes	
Motion Detection	—	
Alarm	Yes	
Slow AE Response	Yes	
Picture Effects	Black & White (Monochrome Image)	
Picture Freeze	Yes	
Electronic-Flip (E-FLIP)	Yes	
Mirror image	Yes	
Slow Shutter	Yes	
Temperature Readout	Yes	
Title Display	Yes	
Date/Time Display	—	
Camera Mode Display	Yes (English)	
Key Switch Control	—	
Camera Operation Switch	—	
<b>Interface</b>		
Video Output (QFHD, FHD, HD)	Digital: Y/Cb/Cr 4:2:2 8bits component, R/G/B 4:4:4 8bits component, Comparable to CEA-861-F *2	
Camera Control Interface	VISCA protocol (CMOS 3.1V) PTP USB 9.6 kbps, 19.2 kbps, 38.4 kbps, 115.2 kbps, Stop bit:1 bit	
<b>General</b>		
Power Requirements	6.0 V to 12.0 V DC	
Power Consumption	3.0 W (When the motor operates:4.0 W)	
Operating Temperature	-5 °C to +60 °C (23 °F to 140 °F)	
Storage Temperature	-20 °C to +60 °C (-4 °F to +140 °F)	
Operating Humidity	20% to 80% (Absolute humidity : 36 g/m <sup>3</sup> )	
Storage Humidity	20% to 95% (Absolute humidity : 36 g/m <sup>3</sup> )	
Dimensions (W x H x D)	50.0 x 60.0 x 93.3 mm (2 x 2 3/8 x 3 3/4 inches)	
Mass	Approx. 275 g (10 oz.)	

\*1 StableZoom increases the magnification by combining optical zoom and digital zoom.

\*2 For supported video formats, refer to Signal System.